

The **Wishbone** Serie

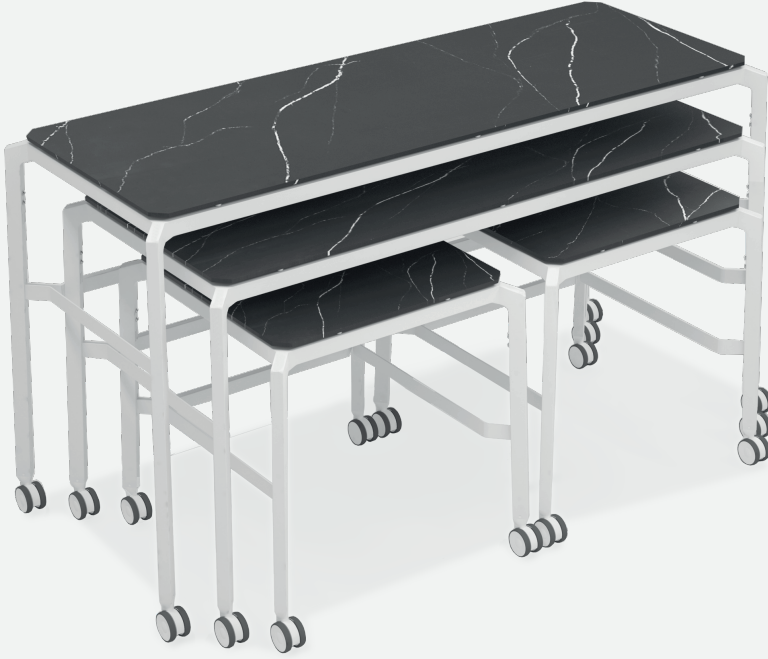

Wishbone

iç içe geçen üniteler
nesting tables



Wishbone Serisi gıda sunumu için her türlü çözümü bir bütün olarak içeren servis sistemi çözümüdür.

Wishbone Serie is a multi-functional counter-top serving system for presentation of food with various serving options.

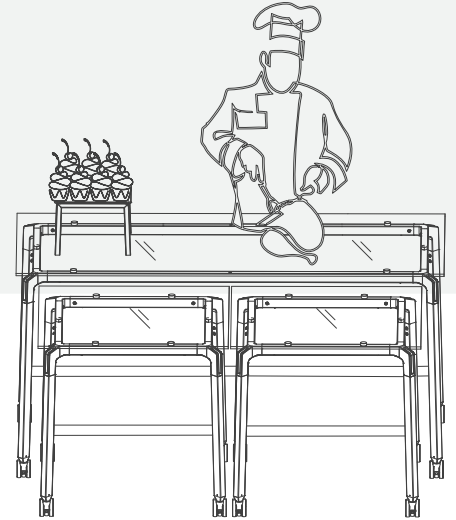

Ürünler kendi içerisindeki çözümleri sayesinde soğutma, ısıtma, pişirme fonksiyonlu ya da nötr olarak servis yapabilme imkanı sağlamaktadır.
Products enable the customers to make selection among cooling, warming cooking, neutral functions or their create their combinations.

Wishbone

İç içe geçen üniteler
nesting tables

Ürünün ana gövdesi AISI 304 kalite paslanmaz çelik ya da epoksi boyalı profil olmak üzere iki alternatiflidir.

The main body of product can be selected between AISI 304 stainless steel or epoxy powder coated profile.

Ürünün üst tablası ise doğal ahşap, kompozit taş ya da cam olarak uygulanabilmektedir.

Table top variations are natural wood, composite stone or glass.

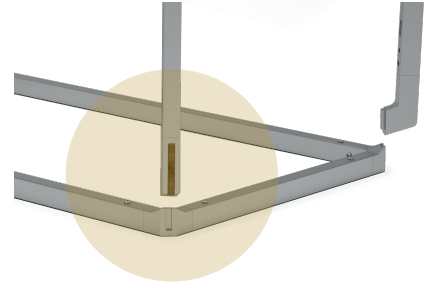
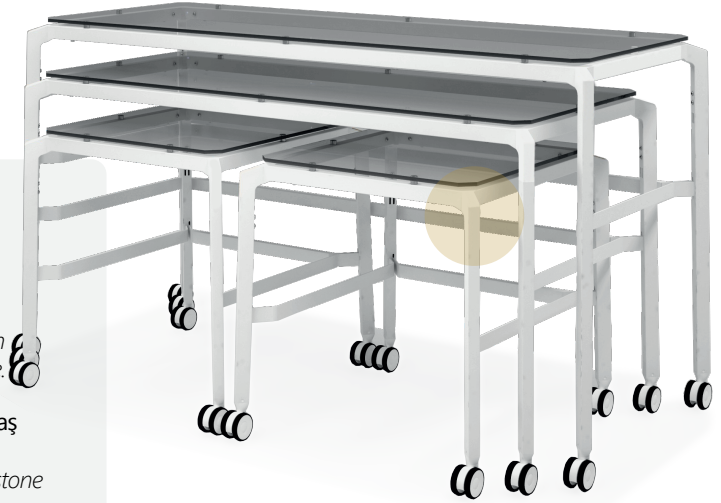
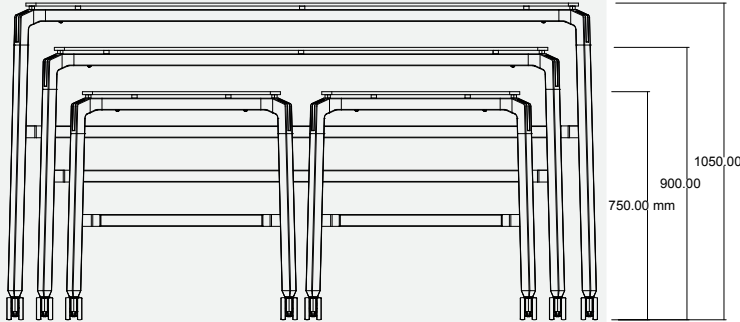

Kolay demonte olma ve depolanma
Easy to disassemble and store

Wishbone

soğuk servis üniteleri cooling service units

Soğutma, cam yüzey soğutma, paslanmaz yüzey soğutma, GN kapları için kullanılan havuz soğutma alternatifleriyle sağlanır. Cihazlar modüller halinde ünite gövdesinin üzerine istenilen şekilde yerleştirilir.

Cooling is provided with glass surface cooling stainless steel surface cooling and cold well cooling with GN pans. The functions are designed to placed on the unite as you prefer.

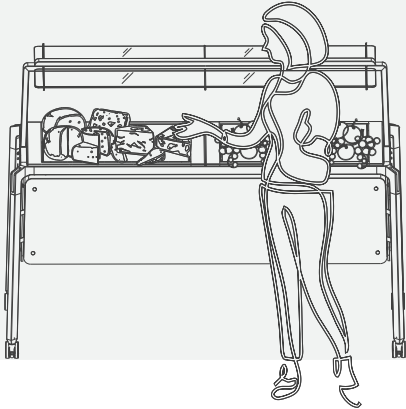

Wishbone

sıcak servis üniteleri
warming service units



Isıtma benmari, indüksiyonlu chafingdish ve temperli cam yüzey ısıtma ile sağlanmaktadır.
Warming is provided with dry bain marie, tempered glass or induction.

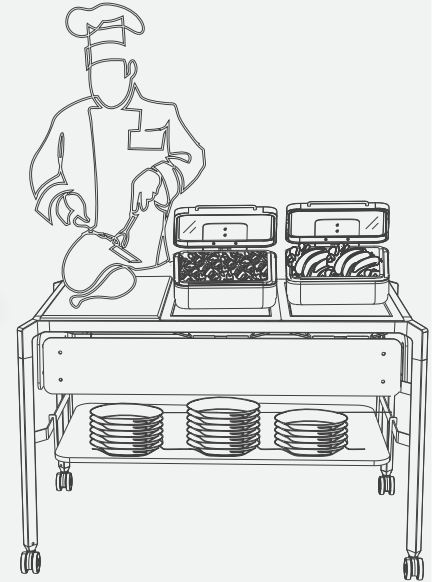

Wishbone

pişirici servis üniteleri
cooking service units

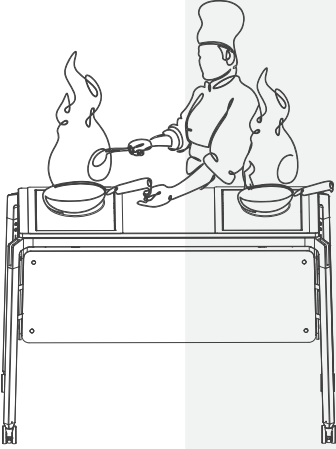

Pişirme elektrikli indüksiyon pişiriciler ve wok ocak ile sağlanır. Pişirici servis üniteleri ile misafirlerinize interaktif gösteriler yapabilirsiniz.

Cooking is provided by induction or wok cooker. It's easy now to make interactive shows to your guests.

Wishbone

aksesuarlar
accessories

**1/1 GN kap üzeri düz tablalı bağlantı
with 1/1 GN container underneath the
flat tray*

*dekor katı
table risers*



Üniteler arası bağlantı tipleri connection types

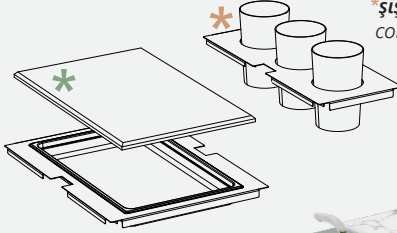

**şişe tutuculu bağlantı
connection with bottle holder*

*tabaklık rafı
plate shelf*

**Düz tabla doğal ahşap, kompozit taş ve paslanmaz çelik olarak uygulanabilir.
The flat tray can be made of as naturel wood, composite stone or stainless steel.*

**Tabaklık rafı doğal ahşap, kompozit taş ve cam olarak uygulanabilir.
The plate shelf can be made of as naturel wood, composite stone or glass.*

soğutma fonksiyonları cooling functions



**2/1 GN Buz veya buz
akülü havuzlu statik
soğutma**
*2/1 GN Static well cooling
with ice or eutectic cooling
packs*

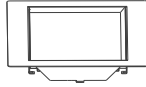

**1/1 GN Buz veya buz
akülü havuzlu statik
soğutma**
*1/1 GN Static well cooling
with ice or eutectic cooling
packs*

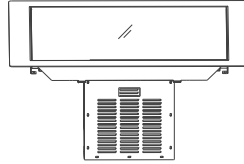

**2/1 GN Kompresörlü
temperli cam yüzey
soğutma**
*2/1 GN Tempered glass
surface cooling with
compressor
(-5°C)*

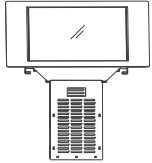

**1/1 GN Kompresörlü
temperli cam yüzey
soğutma**
*1/1 GN Tempered glass
surface cooling with
compressor
(-5°C)*

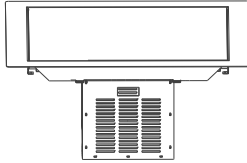

**2/1 GN Kompresörlü
paslanmaz yüzey
soğutma**
*2/1 GN SS surface
cooling with
compressor
(-10°C)*

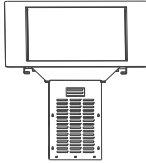

**1/1 GN Kompresörlü
paslanmaz yüzey
soğutma**
*1/1 GN SS surface
cooling with
compressor
(-10°C)*

sıcak tutma fonksiyonları warming functions

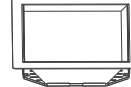

**1/1 GN Benmari
(Jel)**
*1/1 GN Bain Marie
(Gel)*



**2/1 GN Benmari
(Jel)**
*2/1 GN Bain Marie
(Gel)*

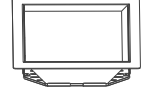

**1/1 GN Benmari
(Elektrik)**
*1/1 GN Bain Marie
(Electric)*



2/1 GN Benmari (Elektrik)
*2/1 GN Bain Marie (Electric)
(Max. 90 °C)*



1/1 GN Temperli Cam (Elektrik)
*1/1 GN Tempered Glass (Electric)
(Max. 90 °C)*

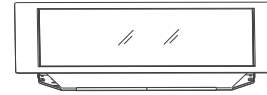

2/1 GN Temperli Cam (Elektrik)
*2/1 GN Tempered Glass (Electric)
(Max. 90 °C)*

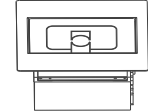

2/3 GN İndüksiyon
1/1 GN Induction

pişirme fonksiyonları cooking functions

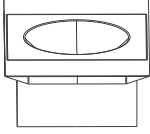

Wok Ocağı (Elektrik)
Wok Cooker (Electric)

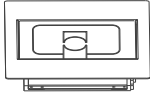

İndüksiyon Pişirici
(Elektrik)
Induction Cooker

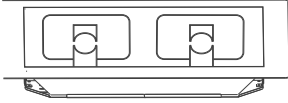

Çoklu Zonlu İndüksiyon Pişirici
(Elektrik)
Multi Zone Induction Cooker

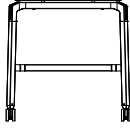

S model

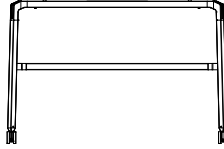

M model

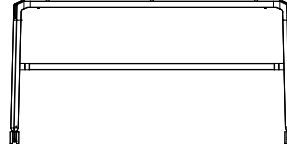

L model

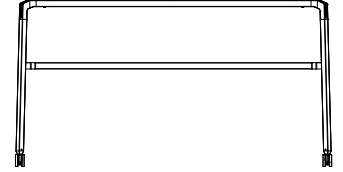

XL model

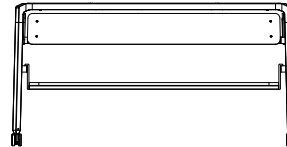
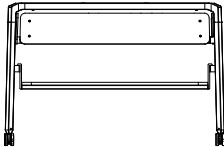
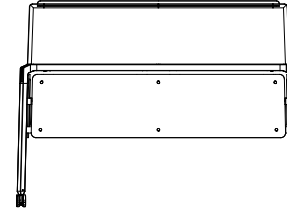
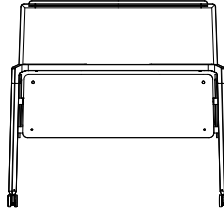
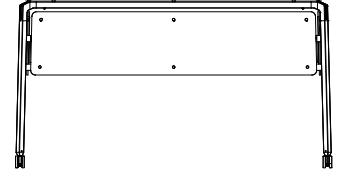
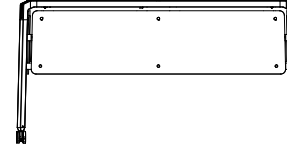
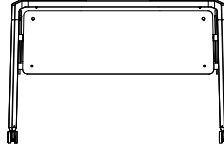
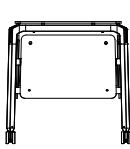

Wishbone Seri ünite modelleri Wishbone Serie unit models

S, L ve XL modelleri iç içe geçen
üniteler için uygundur.

*S, L and XL models are suitable
for nesting.*

M ve L modelleri nefeslik kullanımı
için uygundur.

*M and L models are suitable
for sneeze guard.*

S, M ve L modelleri tabaklık rafı
için uygundur.

*S, M and L models are suitable
for plate shelf.*

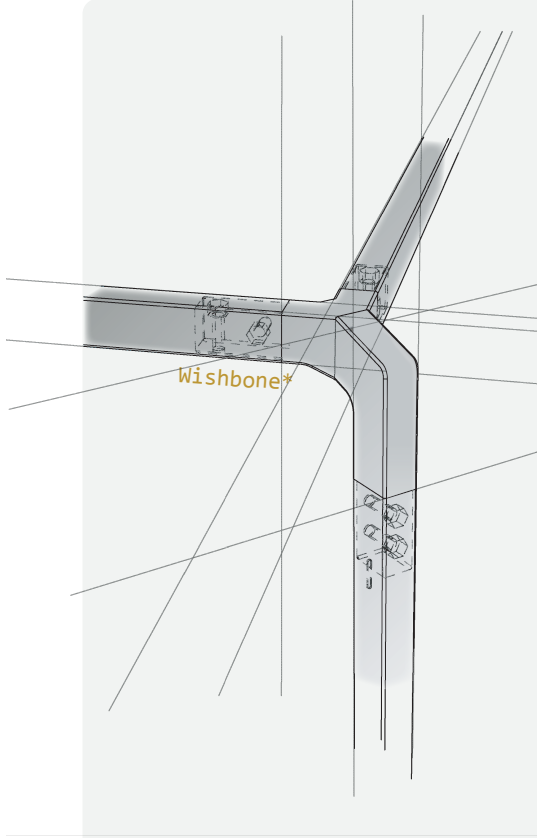

*Diyelim ki Lades kemiği ile bir dilek tuttunuz.Normalde bu kemiği kıran ve daha büyük parçaya sahip olan kişinin dileğinin gerçekleşeceği düşünülmektedir.Lades kemiği 'gelecek için umut ve iyi şans' sembolize etmektedir.

When you make a wish on a wishbone, the wisher who breaks the bone and has the larger piece is thought to have their wish is granted. The wishbone symbolized 'hope for the future and good Luck'.

BASIM YERİ
Nilüfer Matbaası
BASIM TARİHİ
Ağustos 2021

EVINOKS

Fabrika / Factory & Head Office
Demirtaş Organize Sanayi Bölgesi Mimoza Sokak No: 5 16245 Bursa/ TÜRKİYE
+90 224 262 14 00 www.evinoks.com

Visit Our Showrooms at
New York
10 E 34th St, Ditson Building, 8th Floor, New York, NY 10016, USA
Miami
Architecton LLC 8408 NW 17th Street, Miami, FL 33126, USA
IHS Dubai

PO BOX 54083 UBORA TOWER 2 (Office) Business Bay OFFICE 1602, Dubai, United Arab Emirates