

CATALOGUE&PRICE.2019.20

MULTISERVICE

DAL  
STARTING FROM  
12/04/2021

**+5%**

SUL PREZZO DI LISTINO  
ON PRICE LIST









# Storia della Forcar

HISTORY  
HISTOIRE  
GESCHICHTE

## IT

Forcar srl nasce da un'idea di Oriano Tamburini che dopo aver creato il brand Fimar decide di ampliare il ventaglio di prodotti dedicati alla ristorazione e non solo, con una linea di attrezzature professionali per il servizio in sala. Nasce nel 1994 la **Forcar Multiservice**: una linea di carrelli in acciaio e in legno, mobili di servizio, carrelli per alberghi, articoli per la pizzeria e la macelleria, bacinelle e vaschette, fino a pattumiere, portarifiuti e articoli per la pulizia professionale. Una gamma sempre più ampia grazie all'apertura nel 2019 di una nuova area logistica di oltre 17.000 m<sup>2</sup> a Villa Verucchio.

## EN

Forcar srl was born from an idea of Oriano Tamburini who, after creating the brand Fimar, decided to expand the range of products dedicated to catering professionals and other sectors, with a line of professional equipment for waiting service. In 1994 **Forcar Multiservice** was founded: a line of steel and wooden trolleys, service furniture, trolleys for hotels, items for pizzerias and butchers, containers and trays, up to dustbins, waste bins and items for the professional cleaning. A range now increasingly wide thanks to the opening in 2019 of a new logistics area of over 17,000 m<sup>2</sup> located in Villa Verucchio.

## FR

Forcar srl est née de l'idée d'Oriano Tamburini qui, après avoir créé la marque Fimar, a décidé de compléter la gamme de produits destinés à la restauration en créant un équipement professionnel pour le service en salle. En 1994 naît **Forcar Multiservice**: une ligne de chariots en acier et en bois, meubles de service, chariots pour hôtels, articles pour pizzerias et boucheries, bacs et plateaux, poubelles et articles pour le nettoyage professionnel. Une offre en constante évolution grâce à l'ouverture en 2019 d'une nouvelle zone logistique de plus de 17.000 m<sup>2</sup> à Villa Verucchio.















## DE

Forcar srl wurde aus einer Idee von Oriano Tamburini geboren, nach der Gründung der Marke Fimar wollte er die Bandbreite der Produkte für die Gastronomie und verwandte Bereiche, mit einer Reihe von professionellen Geräten für den Tischservice erweitern. 1994 wurde **Forcar Multiservice** gegründet: eine Produktlinie von Stahl- und Holzwagen, Servicemöbeln, Wagen für Hotels, Artikeln für Pizzerien und Metzgereien, Behältern und Blechen bis hin zu Müllbehältern, Mülltonnen und Artikeln für die professionelle Reinigung. Ein zunehmend breiteres Angebot dank der Eröffnung im Jahr 2019 einer neuen Logistikanlage von über 17.000 m<sup>2</sup> in Villa Verucchio.



ICONE

ICONS  
ICÔNES  
SYMBOLE

	IT	EN	FR	DE
	INFORMAZIONI	INFORMATION	INFORMATION	INFO
	NUMERO PIANI	NUMBER OF SHELVES	NOMBRE D'ÉTAGÈRES	STELLFLÄCHENANZAHL
	CARICO MASSIMO	MAXIMUM LOAD	CHARGE MAXIMALE	MAXIMALE BELASTUNG
	DIMENSIONI MACCHINA	MACHINE DIMENSIONS	DIMENSIONS DES MACHINES	MASCHINEN ABMESSUNGEN
	POTENZA	POWER	PUISSANCE	LEISTUNG
	PIASTRE/FUOCHI	PLATES/BURNERS	CUSINIÈRES/BRÛLEURS	KOCHFLÄCHEN/KOCHSTELLEN
	DIMENSIONI DEL PIANO DI LAVORO	DIMENSIONS OF THE WORKTOP	DIMENSIONS DU PLAN DE TRAVAIL	ABMESSUNGEN DER ARBEITSPLATTE
	NUMERO VASCHE	NUMBER OF BOWLS	NOMBRE DE CUVES	ANZAHL DER WANNEN
	ALIMENTAZIONE MONOFASE	SINGLE-PHASE POWER SUPPLY	ALIMENTATION MONOPHASÉE	EINPHASIGE STROMVERSORGUNG
	TEMPERATURA DI LAVORO	WORKING TEMPERATURE	TEMPÉRATURE DE FONCTIONNEMENT	BETRIEBSTEMPERATUR
	TIPO DI GAS	TYPE OF GAS	TYPE DE GAZ	GASTYP
	NUMERO DI TEGLIE	NUMBER OF TRAYS	NOMBRE DE PLAQUES	ANZAHL DER BLECHE
	NUMERO PIATTI	NUMBER OF PLATES	NOMBRE DE PLATS	ANZAHL DER TELLER
	CAPACITÀ DEL CONTENITORE	CONTAINER CAPACITY	CAPACITÉ DU CONTENANT	BEHÄLTERKAPAZITÄT



# INDICE

INDEX  
TABLE DES MATIÈRES  
INHALT



CATEGORIE	IT	EN	FR	DE	
<b>CARRELLI E MOBILI DI SERVIZIO IN LEGNO</b>	CARRELLI GUÉRIDON	GUÉRIDON TROLLEYS	CHARIOTS GUÉRIDON	GUÉRIDON WAGEN	13
<b>WOODEN SERVICE TROLLEYS AND SERVING FURNITURE</b>	CARRELLI DI SERVIZIO IN LEGNO	WOODEN SERVICE TROLLEYS	CHARIOTS DE SERVICE EN BOIS	SERVIERWAGEN AUS HOLZ	15
<b>CHARIOTS ET MEUBLES DE SERVICE EN BOIS</b>	CARRELLI FLAMBÈ	FLAMBÈ TROLLEYS	CHARIOTS FLAMBÉS	FLAMBÉ WAGEN	25
<b>SERVIERWAGEN UND SERVICEMÖBEL AUS HOLZ</b>	MOBILI DI SERVIZIO IN LEGNO	WOODEN SERVING FURNITURE	MEUBLES DE SERVICE EN BOIS	SERVICEMÖBEL AUS HOLZ	27
<b>CARRELLI DI SERVIZIO IN ACCIAIO INOX AISI 304</b>	CARRELLI DI SERVIZIO IN ACCIAIO INOX E RIPIANI IN NOBILITATO	STAINLESS STEEL SERVICE TROLLEYS WITH SHELVES MADE OF MELAMINE	CHARIOTS DE SERVICE ET ÉTAGÈRES EN ACIER INOX EN MÉLAMINE	SERVIERWAGEN AUS EDELSTAHL MIT ABLAGEN AUS MELAMINHARZ	37
<b>SERVICE TROLLEYS IN STAINLESS STEEL AISI 304</b>	CARRELLI DI SERVIZIO IN ACCIAIO INOX	STAINLESS STEEL SERVICE TROLLEYS	CHARIOTS DE SERVICE EN ACIER INOX	SERVIERWAGEN AUS EDELSTAHL	39
<b>CHARIOTS DE SERVICE EN ACIER INOX AISI 304</b>	CARRELLI DI SERVIZIO MULTIUSO IN PLASTICA	MULTIPURPOSE PLASTIC SERVICE TROLLEYS	CHARIOTS POLYVALENTE EN PLASTIQUE	MEHRZWECK-SERVICEWAGEN AUS KUNSTSTOFF	49
<b>SERVIERWAGEN AUS EDELSTAHL AISI 304</b>	CARRELLI REFRIGERATI IN LEGNO	WOODEN REFRIGERATED TROLLEYS	CHARIOTS RÉFRIGÉRÉS EN BOIS	GEKÜHLTE SERVIERWAGEN AUS HOLZ	51
<b>CARRELLI ED ESPOSITORI REFRIGERATI E TERMICI IN LEGNO</b>	ESPOSITORI REFRIGERATI IN LEGNO	WOODEN REFRIGERATED DISPLAYS	VITRINES RÉFRIGÉRÉES EN BOIS	GEKÜHLTE VITRINE AUS HOLZ	54
<b>HEATED TROLLEYS AND DISPLAYS REFRIGERATI E TERMICI IN LEGNO</b>	CARRELLI TERMICI A BAGNOMARIA IN LEGNO	WOODEN BAIN-MARIE TROLLEYS	CHARIOTS CHAUDES BAIN-MARIE EN BOIS	BAIN-MARIE WAGEN AUS HOLZ	57
<b>CHARIOTS ET VITRINES RÉFRIGÉRÉS ET CHAUFFÉS EN BOIS</b>	ESPOSITORI TERMICI A BAGNOMARIA IN LEGNO	WOODEN HEATED BAIN-MARIE DISPLAYS	VITRINES CHAUDES BAIN-MARIE EN BOIS	BEHEIZTE BAIN-MARIE VITRINE AUS HOLZ	61
<b>GEKÜHLTE UND BEHEIZTE SERVIERWAGEN UND VITRINEN AUS HOLZ</b>	ESPOSITORI IN LEGNO NEUTRO	DISPLAYS IN NEUTRAL WOOD	VITRINES EN BOIS NEUTRE	AUFSATZVITRINEN AUS NEUTRALEM HOLZ	64
	CARRELO TERMICO, IDEALE PER BOLLITI E ARROSTI	HEATED TROLLEYS, IDEAL FOR BOILED AND ROASTED MEATS	CHARIOTS CHAUFFANTS, IDÉAUX POUR BOUILLIR ET RÔTIR	BEHEIZTE SERVIERWAGEN, IDEAL FÜR GEKOCHTES UND GEBRATENES FLEISCH	64
	MENSOLE IN LEGNO PER UNIONE	CONNECTION WOODEN SHELF	ÉTAGÈRES EN BOIS POUR RACCORDS	VERBINDUNGSREGALE AUS HOLZ	66
<b>CARRELLI REFRIGERATI E TERMICI, VASCHE DA INCASSO, DISTRIBUTORI PRIMA COLAZIONE, IN ACCIAIO INOX</b>	VASCHE REFRIGERATE IN ACCIAIO INOX (DROP-IN)	STAINLESS STEEL REFRIGERATED BOWLS (DROP-IN)	CUVES RÉFRIGÉRÉES EN ACIER (A POSER)	KÜHLWANNEN AUS EDELSTAHL (DROP-IN)	69
<b>REFRIGERATED AND HEATED TROLLEYS, BUILT-IN BOWLS, BREAKFAST DISPENSERS, MADE OF STAINLESS STEEL</b>	VASCHE TERMICHE A BAGNOMARIA IN ACCIAIO INOX	STAINLESS STEEL HEATED BAIN-MARIE BOWLS	CUVES BAIN-MARIE EN ACIER INOX	BAIN-MARIE HEIZWANNEN AUS EDELSTAHL	70
<b>CHARIOTS RÉFRIGÉRÉS ET CHAUFFÉS, BACS INTÉGRÉS, DISTRIBUTEURS DE PETIT DÉJEUNER, EN ACIER INOX</b>	CARRELLI REFRIGERATI IN ACCIAIO INOX	REFRIGERATED STAINLESS STEEL TROLLEYS	CHARIOTS RÉFRIGÉRÉS EN ACIER INOX	GEKÜHLTE SERVIERWAGEN AUS EDELSTAHL	71
<b>GEKÜHLTE UND BEHEIZTE SERVIERWAGEN, EINGEBaute BEHÄLTER, FRÜHSTÜCKSSPENDER, AUS EDELSTAHL</b>	CARRELLI TERMICI IN ACCIAIO INOX	HEATED STAINLESS STEEL TROLLEYS	CHARIOTS CHAUFFANTS EN ACIER INOX	BEHEIZTE SERVIERWAGEN AUS EDELSTAHL	72
	DISTRIBUTORI PRIMA COLAZIONE IN ACCIAIO INOX	STAINLESS STEEL BREAKFAST DISPENSERS	DISTRIBUTEURS DE PETIT DÉJEUNER EN ACIER INOX	FRÜHSTÜCKSSPENDER SERVIERWAGEN AUS EDELSTAHL	80

CATEGORIE	IT	EN	FR	DE	
ELEMENTI RISCALDANTI E VETRINE NEUTRE	TAVOLE CALDE	HEATED TABLES	TABLES CHAUDES	BEHEIZTE TISCHE	83
	PIANI CALDI	HEATED TOPS	PLANS DE TRAVAIL CHAUDS	BEHEIZTE ARBEITSFLÄCHE	86
HEATING ELEMENTS AND NEUTRAL DISPLAYS	LAMPADE A RAGGI INFRAROSSI	INFRARED LAMPS	LAMPES INFRAROUGES	INFRAROT-LAMPEN	87
	VETRINE RISCALDANTI	HEATED DISPLAY	VITRINES CHAUFFÉES	BEHEIZTE VITRINEN	90
ELÉMENTS CHAUFFANTS ET VITRINES NEUTRES	VETRINE NEUTRE	NEUTRAL DISPLAY	VITRINES NEUTRES	NEUTRALE VITRINEN	91
	MOBILETTI SCALDAPIAZZI	PLATES HEATING CABINETS	ARMOIRES CHAUFFE-PLATS	TELLERWÄRMER	94
HEIZELEMENTE UND NEUTRALE VITRINEN	VETRINE RISCALDANTI CON GRIGLIE	HEATED DISPLAY CASES WITH GRIDS	VITRINES CHAUFFÉES AVEC GRILLES	BEHEIZTE VITRINEN MIT GITTER	95
	CARRELLI PORTAVASSOI GN	GN TRAY TROLLEYS	CHARIOTS À PLATEAUX GN	SERVIERWAGEN FÜR GN PLATTEN	97
CARRELLI PER LA CUCINA	CARRELLI PORTAVASSOI UNIVERSALI	UNIVERSAL TRAY TROLLEYS	CHARIOTS À PLATEAUX UNIVERSELS	UNIVERSAL SERVIERWAGEN	100
KITCHEN TROLLEYS	CARRELLI PORTATEGLIE GN	GASTRONOM GN PANS TROLLEYS	CHARIOTS À PLAQUES GN	SERVIERWAGEN FÜR GASTRONOMIE GN BLECHE	102
CHARIOTS POUR LA CUISINE	CARRELLI PORTATEGLIE PER PASTICCERIA	PASTRY PANS TROLLEY	CHARIOTS POUR PLAQUES DE PÂTISSERIE	SERVIERWAGEN FÜR KONDITOREI BLECHE	104
KÜCHENWAGEN	PORTAPIATTI DA BANCO, PORTAPIATTI DA PARETE E CARRELLI	TABLE TOP PLATE RACK, WALL PLATE RACK AND TROLLEYS	ÉTAGÈRE À ASSIETTES DE TABLE, PORTE-ASSIETTES À MURO ET CHARIOTS	TISCH-TELLERSTÄNDER, WANDTELLERHALTER. UND TELLERWAGEN	107
CARRELLI PORTAPIATTI E CESTELLI	CARRELLI PORTAPIATTI ARMADIATI	CABINET PLATE TROLLEYS	CHARIOTS PORTE-ASSIETTES SUR ÉLÉMENT FERMÉ	TELLERWAGEN MIT SCHRANKELEMENT	110
	CARRELLI PORTAPIATTI RISCALDATI	HEATED PLATE STORAGE TROLLEYS	CHARIOTS CHAUFFÉS À ASSIETTES	BEHEIZTE TELLERWAGEN	111
PLATE AND BASKETS TROLLEYS	CARRELLI PORTAPIATTI REFRIGERATI	REFRIGERATED PLATE STORAGE TROLLEYS	CHARIOTS RÉFRIGÉRÉS À ASSIETTES	GEKÜHLTE TELLERWAGEN	112
CHARIOTS POUR PANIERS ET ASSIETTES	CARRELLI PORTAPIATTI PER TRASPORTO E RITIRO	PLATES TRANSPORT AND COLLECTION TROLLEYS	CHARIOTS DE COLLECTE, DE DISTRIBUTION ET DE STOCKAGE DE PLATEAUX	WAGEN ZUM SAMMELN, VERTEILEN UND LAGERN VON TABLETTS	113
SERVIERWAGEN FUER TELLER UND KÖRBE	SCOLAPIATTI E BICCHIERI	PLATE AND GLASSES DRAINER	ÉGOUTTOIR POUR VERRES ET ASSIETTES	HÄNGE-ABTROPFER FÜR TELLER UND GLÄSER	113
	CARRELLI PORTACESTELLI	BASKET TROLLEY	CHARIOT À PANIERS	KORBWAGEN	114
CARRELLI PORTACASSETTE PER IMPASTI PIZZA	TROLLEY FOR PIZZA DOUGH CONTAINERS	CHARIOT À BACS POUR PÂTE À PIZZA	WAGEN FÜR PIZZATEIGBEHÄLTER	116	
CESTELLI PER LAVASTOVILIE	DISHWASHER BASKETS	PANIERS POUR LAVE-VAISSELLE	KÖRBE FÜR GESCHIRRPÜLER	117	
CARRELLI E ARTICOLI PER IL SERVIZIO IN CAMERA	CARRELLI PER LA COLAZIONE	BREAKFAST TROLLEYS	CHARIOTS DE PETIT DÉJEUNER	FRÜHSTÜCKSWAGEN	119
	CARRELLI PORTAVALIGIE E PORTABITI	LUGGAGE TROLLEYS AND CLOTHES RACKS	CHARIOTS À BAGAGES ET PORTE-VÊTEMENTS	KÖFFERWAGEN UND KLEIDERSTÄNDER	121
TROLLEYS AND EQUIPMENT FOR ROOM SERVICE	REGGI VALIGIE	LUGGAGE HOLDER	SUPPORTS DE BAGAGES	KOFFERTRÄGER	125
CHARIOTS ET ARTICLES POUR LE ROOM SERVICE	CARRELLI PER TRASPORTO PESANTE	TROLLEYS FOR HEAVY TRANSPORT	CHARIOTS POUR CHARGES LOURDES	WAGEN FÜR DEN SCHWERTRANSPORT	126
WAGEN UND AUSTRÜSTUNG FÜR DEN ZIMMERSERVICE	ASTA DELIMITA CORSIA	RETRACTABLE BARRIERS	DÉLIMITEUR DE ZONE	BEGRENZUNG	127
	MACCHINE PULISCI SCARPE	SHOE CLEANER MACHINE	MACHINE DE NETTOYAGE DE CHAUSSURES	SCHUHPUTZMASCHINE	129

CATEGORIE	IT	EN	FR	DE	
<b>CARRELLI PORTABIANCHERIA, RIFORNIMENTO FRIGOBAR, PULIZIA E MULTIUSO</b> <b>LAUNDRY, MINIBAR, CLEANING AND MULTI-PURPOSE TROLLEYS</b> <b>CHARIOTS À LINGE, RECHARGE MINIBAR, NETTOYAGE ET POLYVALENT</b> <b>WÄSCHEREI-, MINIBAR-, REINIGUNG- UND MEHRZWECKWAGEN</b>	CARRELLI PORTABIANCHERIA	LAUNDRY TROLLEYS	CHARIOTS À LINGE	WÄSCHEWAGEN	<b>131</b>
	CARRELLI PER RIFORNIMENTO FRIGOBAR	TROLLEYS FOR MINI-BAR REFUELLING	CHARIOTS DE REMPLISSAGE POUR MINIBARS	WAGEN FÜR DIE MINIBARFÜLLUNG	<b>134</b>
	CESTONE E CARRELLI CON CESTO PER BIANCHERIA	BASKET AND TROLLEYS WITH LAUNDRY BASKET	PANIERI ET CHARIOTS AVEC PANIER À LINGE	KORB UND WAGEN MIT WÄSCHEKORB	<b>135</b>
	CARRELLI PER PULIZIA	CLEANING TROLLEYS	CHARIOTS DE NETTOYAGE	REINIGUNGSWAGEN	<b>136</b>
	CARRELLO MULTIUSO IN PLASTICA	MULTI-PURPOSE PLASTIC TROLLEY	CHARIOT POLYVALENT EN PLASTIQUE	MEHRZWECK-KUNSTSTOFFWAGEN	<b>140</b>
<b>ARTICOLI VARI PER LA MACELLERIA</b> <b>ITEMS FOR THE MEAT PROCESSING</b> <b>ARTICLES POUR LA TRANSFORMATION DE LA VIANDE</b> <b>ARTIKEL FÜR DIE FLEISCHVERARBEITUNG</b>	LAVAMANI	HAND WASHER	LAVE-MAINS	HANDWÄSCHER	<b>143</b>
	STERILIZZATORI ELETTRICI PER COLTELLI	ELECTRIC STERILIZERS FOR KNIVES	DISPOSITIFS ÉLECTRIQUES DE DÉSINFECTION POUR COUTEAUX	ELEKTRISCHE ENTKEIMUNGSGERÄTE FÜR MESSER	<b>145</b>
	GREMBIULI E GUANTI	APRONS AND GLOVES	TABLIERS ET GANTS	SCHÜRZEN UND HANDSCHUHE	<b>146</b>
	CEPPI	BUTCHER BLOCKS	BLOCS DE BOUCHERIE	METZGERBLOCKS	<b>147</b>
	TAGLIERI E RASCHIETTO	CUTTING BOARDS AND SCRAPER	PLANCHES À DÉCOUPER ET RACLOIR	SCHNEIDEBRETTER UND ABSTREIFER	<b>149</b>
	SCAFFALATURA MODULARE	MODULAR SHELVING	RAYONNAGE MODULAIRE	MODULAR REGALE	<b>150</b>
	ELETTROINSETTICIDI	ELECTRO-INSECTICIDES	ELECTRO-INSECTICIDES	ELEKTROINSEKT-KILLER	<b>151</b>
<b>ATTREZZATURA PER LA COLAZIONE</b> <b>BREAKFAST EQUIPMENT</b> <b>ÉQUIPEMENT DE PETIT-DÉJEUNER</b> <b>FRÜHSTÜCKSAUSRÜSTUNG</b>	CHAFING DISHES	CHAFING DISHES	CHAFING DISHES	CHAFING DISHES	<b>153</b>
	ZUPPIERA ELETTRICA	ELECTRIC SOUP TUREEN	SOUPIÈRE ÉLECTRIQUE	ELEKTRISCHE SUPPENSCHÜSSEL	<b>156</b>
	DISTRIBUTORI CAFFÈ, BEVANDE E CEREALI	COFFEE, DRINKS AND CEREALS DISPENSERS	DISTRIBUTEURS DE CAFÉ, DE BOISSONS ET DE CÉRÉALES	KAFFEE-, GETRÄNKE- UND MÜSLISPENDER	<b>156</b>
	FORNELLO FLAMBÈ	FLAMBÉ COOKER	CUISINIÈRE FLAMBÉE	FLAMBÉ GASHERD	<b>158</b>
	PADELLA FLAMBÈ	FLAMBÉ PAN	CASSEROLE À FLAMBER	FLAMBIERPFANNE	<b>158</b>
<b>ARTICOLI VARI PER CUCINA E PIZZERIA</b> <b>ITEMS FOR COOKING AND PIZZERIA</b> <b>ARTICLES POUR LA CUISINE ET POUR LA PIZZERIA</b> <b>KOCH- UND PIZZERIAARTIKEL</b>	BACINELLE, TEGLIE, VASCHE PER GELATO, VASSOI, APRISCATOLE, MORSO PER PROSCIUTTO, SPATOLE, PALETTE, PINZE, ROTELLE, TAGLIERI, CONTENITORI IMPASTI PER PIZZA, BILANCE	CONTAINERS, PANS, ICE CREAM CONTAINERS, TRAYS, CAN OPENERS, HAM CLAMPS, SPATULAS, SLIDES, CLAMPS, ROLLS, CHOPPING BOARDS, PIZZA DOUGH CONTAINERS, SCALES	BACS, PLAQUES, BACS À CRÈME GLACÉE, PLATEAUX, OUVRE-BOÎTES, OUVRE-BOÎTES, ÉTAU À JAMBON, SPATULES, PALETTES, PINCES, ROUES, PLANCHES À DÉCOUPER, RÉCIPIENTS À PÂTE DE PIZZA, BALANCES	BEHÄLTER, BLECHE, EISBEHÄLTER, SCHALEN, DOSENÖFFNER, SCHINKENKLAMMERN, SPATEL, SCHAUFELN, KLAMMERN, ROLLEN, SCHNEIDEBRETTER, PIZZATEIGBEHÄLTER, WAAGEN	<b>161</b>
<b>PATTUMIERE-PORTARIFIUTI</b> <b>GARBAGE AND DUST</b> <b>BINSPOUBELLES</b> <b>MÜLL- UND ABFALLBEHÄLTER</b>	PATTUMIERE-PORTARIFIUTI	GARBAGE AND DUST	BINSPOUBELLES	MÜLL- UND ABFALLBEHÄLTER	<b>177</b>
	CONDIZIONI GENERALI DI VENDITA	GENERAL SALES CONDITIONS	CONDITIONS GÉNÉRALES DE VENTE	ALLGEMEINE VERKAUFSBEDINGUNGEN	<b>182</b>



# Carrelli e mobili di servizio in legno

WOOD TROLLEYS AND SERVICE FURNITURE  
CHARIOTS ET MEUBLES DE SERVICE EN BOIS  
WAGEN UND SERVICEMÖBEL AUS HOLZ

## CA 901 2R



## CA 901

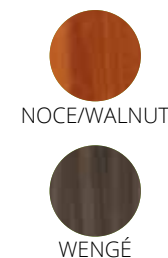

CA 901 2R

CA 901

IT Carrelli Guéridon. Struttura portante in tubo di acciaio inox - ripiani in nobilitato con bordo in gomma - carrelli disponibili nei colori noce e wengé - 2 ruote multidirezionali ø 95 mm.

IT Carrelli Guéridon. Struttura portante in tubo di acciaio inox - ripiani in nobilitato con bordo in gomma - carrelli disponibili nei colori noce e wengé - 4 ruote multidirezionali ø 95 mm.

EN Guéridon trolleys. Tubular stainless steel supporting structure - melamine shelves with rubber edges - trolleys available in walnut and wenge colour - 2 multidirectional wheels ø 95 mm.

EN Guéridon trolleys. Tubular stainless steel supporting structure - melamine shelves with rubber edges - trolleys available in walnut and wenge colour - 4 multidirectional wheels ø 95 mm.

FR Chariots Guéridon. Structure portante en tube d'acier inox - étagères en mélaminé avec bord en caoutchouc - chariots disponibles en noyer et wengé - 2 roues multidirectionnelles ø 95 mm.

FR Chariots Guéridon. Structure portante en tube d'acier inox - étagères en mélaminé avec bord en caoutchouc - chariots disponibles en noyer et wengé - 4 roues multidirectionnelles ø 95 mm.

DE Guéridon Wagen. Stützrahmen aus Edelstahlrohr - Regale aus Melamin mit Gummikante - Wagen in den Farben Nussbaum und Wenge erhältlich - 2 Mehrweg-Räder ø 95 mm.

DE Guéridon Wagen. Stützrahmen aus Edelstahlrohr - Einlegeböden aus Melamin mit Gummikante - Wagen in den Farben Walnuss und Wenge erhältlich - 4 Mehrwegräder ø 95 mm.

i	CA 901 2R noce-walnut	CA 901 2RW wengé
↗ cm	70 x 50 x 78(h) cm	
N.	2	
MAX Kg	40 Kg	
	250 €	

i	CA 901 noce-walnut	CA 901W wengé
↗ cm	70 x 50 x 78(h) cm	
N.	2	
MAX Kg	40 Kg	
	260 €	

+5%

Carrelli Guéridon  
Guéridon trolleys

OPTIONAL



## CL 903



CL 903B

IT Carrelli Guéridon. Struttura portante in legno massello - ripiani in nobilitato con bordo in gomma - carrelli disponibili nei colori noce, wengé, bianco o nero - ruote multidirezionali ottonate ø 95 mm.

EN Guéridon trolleys. Solid wood supporting structure - melamine shelves with rubber edges - trolleys available in walnut, wenge, white or black colour - multidirectional brass-plated wheels ø 95 mm.

FR Chariots Guéridon. Structure portante en bois massif - étagères en mélaminé avec bord en caoutchouc - chariots disponibles en noyer, wengé, blanc ou noir - roues multidirectionnelles laitonées ø 95 mm.

DE Guéridon Wagen. Stützrahmen aus Massivholz- Einlegeböden aus Melamin mit Gummikante - Wagen in den Farben Walnuss, Wenge, Schwarz und Weiß erhältlich - messingbeschichtete Mehrwegräder ø 95 mm.

i	CL 903 noce-walnut	CL 903W wengé	CL 903B bianco-white	CL 903N nero-black
↗ cm	70 x 50 x 78(h) cm			
N.	2			
MAX Kg	40 Kg			
	240 €		480 €	

## CLE



I tempi di consegna potrebbero variare  
Delivery times may vary

CLE

IT Carrelli Guéridon. Struttura in legno massello - ripiani in multistrato di betulla - disponibile nel colore noce - ruote multidirezionali ø 95 mm. Su richiesta disponibili altri colori RAL.

EN Guéridon trolleys. Solid wood structure - multi-layered birch shelves - available in walnut colour - multidirectional brass-plated wheels ø 95 mm. Further RAL colours available on request.

FR Chariots Guéridon. Structure en bois massif - étagères en multicouche de bouleau - disponible en couleur noyer - roues multidirectionnelles de ø 95 mm. Couleurs RAL disponibles sur demande.

DE Guéridon Wagen. Massivholzrahmen - Einlegeböden aus Birkensperholz - erhältlich in Walnussfarbe - Mehrwegräder ø 95 mm. RAL-Farben auf Anfrage erhältlich.

i	CLE noce-walnut	CLE ral
↗ cm	90 x 45 x 77(h) cm	
N.	2	
MAX Kg	40 Kg	
	410 €	510 €

## CLP 2002



CLP 2002N

- IT Carrelli di servizio in legno. Struttura in legno massello - ripiani in multistrato di betulla - maniglie di spinta integrate nel piano superiore - ringhiere di contenimento sui piani inferiori - carrelli disponibili nei colori noce, wengé, bianco e nero - ruote multidirezionali cromate ø 95 mm.
- EN Wooden service trolleys. Solid wood structure - birch multi-layered wood shelves - integrated push handles in the upper shelf - retaining rails on the lower shelves - trolleys available in walnut, wengé, white and black colour - multidirectional chrome-plated wheels ø 95 mm.
- FR Chariots de service en bois. Structure en bois massif - étagères en bouleau multicouche - poignées de poussée intégrées à l'étagère supérieur - profilés de retenue aux étagères inférieurs - chariots disponibles en noyer, wengé, blanc et noir - roues multidirectionnelles chromées ø 95 mm.
- DE Servicewagen aus Holz. Massivholzstruktur - Ablageflächen aus Birkensperrholz - Schubgriffe eingebaut an der obersten Fläche - Halterungen in den untersten Etagen - Wagen in Nussbaum, Wenge, Weiß und Schwarz erhältlich - Mehrweg-Chromräder ø 95 mm.

i	CLP 2002 noce-walnut	CLP 2002W wengé	CLP 2002B bianco-white	CLP 2002N nero-black
cm	110 x 55 x 82(h) cm			
N.	2			
MAX Kg	80 Kg			
	460 €		560 €	

## CLP 2002 L40

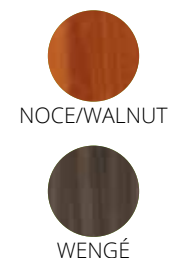

CLP 2002 L40W

- IT Carrelli di servizio in legno. Struttura in legno massello - ripiani in multistrato di betulla - maniglie di spinta integrate nel piano superiore - ringhiere di contenimento sui piani inferiori - carrelli disponibili nei colori noce e wengé - ruote multidirezionali cromate ø 95 mm.
- EN Wooden service trolleys. Solid wood structure - birch multi-layered wood shelves - integrated push handles in the upper shelf - retaining rails on the lower shelves - trolleys available in walnut and wengé colour - multidirectional chrome-plated wheels ø 95 mm.
- FR Chariots de service en bois. Structure en bois massif - étagères en bouleau multicouche - poignées de poussée intégrées à l'étagère supérieur - profilés de retenue aux étagères inférieurs - chariots disponibles en noyer et wengé - roues multidirectionnelles chromées ø 95 mm.
- DE Servicewagen aus Holz. Massivholzstruktur - Ablageflächen aus Birkensperrholz - Schubgriffe eingebaut an der obersten Fläche - Halterungen in den untersten Etagen - Wagen in Nussbaum und Wenge - Mehrweg-Chromräder ø 95 mm.

i	CLP 2002 L40 noce-walnut	CLP 2002 L40W wengé
cm	110 x 40 x 82(h) cm	
N.	2	
MAX Kg	80 Kg	
	400 €	

Carrelli di servizio in legno  
Wooden service trolleys

+5%

OPTIONAL



## CLP 2003



CLP 2003B

- IT** Carrelli di servizio in legno. Struttura in legno massello - ripiani in multistrato di betulla - maniglie di spinta integrate nel piano superiore - ringhiere di contenimento sui piani inferiori - carrelli disponibili nei colori noce, wengé, bianco e nero - ruote multidirezionali cromate ø 95 mm.
- EN** Wooden service trolleys. Solid wood structure - birch multi-layered wood shelves - integrated push handles in the upper shelf - retaining rails on the lower shelves - trolleys available in walnut, wengé, white and black colour - multidirectional chrome-plated wheels ø 95 mm.
- FR** Chariots de service en bois. Structure en bois massif - étagères en bouleau multicouche - poignées de poussée intégrées à l'étagère supérieur - profilés de retenue aux étagères inférieurs - chariots disponibles en noyer, wengé, blanc et noir - roues multidirectionnelles chromées ø 95 mm.
- DE** Servicewagen aus Holz. Massivholzstruktur - Ablageflächen aus Birkensperrholz - Schubgriffe eingebaut an der obersten Fläche - Halterungen in den untersten Etagen - Wagen in Nussbaum, Wenge, Weiß und Schwarz erhältlich - Mehrweg-Chromräder ø 95 mm.

## CLP 2003 L40

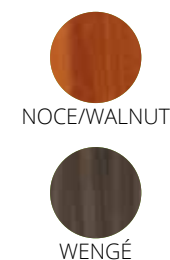

CLP 2003 L40

- IT** Carrelli di servizio in legno. Struttura in legno massello - ripiani in multistrato di betulla - maniglie di spinta integrate nel piano superiore - ringhiere di contenimento sui piani inferiori - carrelli disponibili nei colori noce e wengé - ruote multidirezionali cromate ø 95 mm.
- EN** Wooden service trolleys. Solid wood structure - birch multi-layered wood shelves - integrated push handles in the upper shelf - retaining rails on the lower shelves - trolleys available in walnut and wengé colour - multidirectional chrome-plated wheels ø 95 mm.
- FR** Chariots de service en bois. Structure en bois massif - étagères en bouleau multicouche - poignées de poussée intégrées à l'étagère supérieur - profilés de retenue aux étagères inférieurs - chariots disponibles en noyer et wengé - roues multidirectionnelles chromées ø 95 mm.
- DE** Servicewagen aus Holz. Massivholzstruktur - Ablageflächen aus Birkensperrholz - Schubgriffe eingebaut an der obersten Fläche - Halterungen in den untersten Etagen - Wagen in Nussbaum und Wenge - Mehrweg-Chromräder ø 95 mm.

i	CLP 2003 noce-walnut	CLP 2003W wengé	CLP 2003B bianco-white	CLP 2003N nero-black
cm	110 x 55 x 89(h) cm			
N.	3			
MAX Kg	80 Kg			
	620 €		780 €	

i	CLP 2003 L40 noce-walnut	CLP 2003 L40W wengé
cm	110 x 40 x 89(h) cm	
N.	3	
MAX Kg	80 Kg	
	510 €	



# CL 2000



CL 2000

IT Carrelli di servizio in legno. Struttura in legno multistrato di betulla - ripiani in nobilitato - cornice perimetrale e maniglia in legno massello - disponibili nei colori noce e wengé - ruote multidirezionali di serie cromate ø 95 mm.

EN Wooden service trolleys. Birch multi-layered wood structure - melamine shelves - solid wood perimeter frame and handle - available in walnut and wenge colour - standard multidirectional chrome-plated wheels ø 95 mm.

FR Chariots de service en bois. Structure en bouleau multicouche - étagères en bois mélaminé - cadre périmétral et poignée en bois massif - disponible en noyer et wengé - de série roues multidirectionnelles chromées ø 95 mm.

DE Servicewagen aus Holz. Struktur aus Birkensperrholz - Regale aus melaminharzbeschichtetem Birkenholz - Zierrahmen und Griff aus Struktur aus Birkenfurnierholz - Ablagefläche aus Furnierholz - umlaufender Rahmen und Griff aus Massivholz - erhältlich in den Farben Nussbaum und Wenge - serienmäßig mit Mehrweg-Chromräder ø 95 mm.

	CL 2000 noce-walnut	CL 2000W wengé
	86 x 55 x 85(h) cm	
	2	
	80 Kg	
	570 €	

# CL 2001

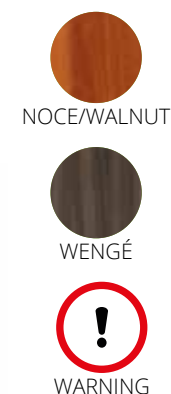

CL 2001W

IT Carrelli di servizio in legno. Struttura in legno multistrato di betulla - ripiani in nobilitato - cornice perimetrale in legno massello - disponibili nei colori noce e wengé - ruote multidirezionali cromate ø 95 mm.

EN Wooden service trolleys. Birch multi-layered wood structure - melamine shelves - solid wood perimeter frame - available in walnut and wenge colour - multidirectional chrome-plated wheels ø 95 mm.

FR Chariots de service en bois. Structure en bouleau mélaminé - étagères en bois multicouche - cadre périmétral en bois massif - disponible en noyer et wengé - roues multidirectionnelles chromées ø 95 mm.

DE Servicewagen aus Holz. Struktur aus Birkensperrholz - Regale aus melaminharzbeschichtetem Birkenholz - Zierrahmen und Griff aus Struktur aus Birkenfurnierholz - Ablagefläche aus Furnierholz - umlaufender Rahmen aus Massivholz - erhältlich in den Farben Nussbaum und Wenge - Mehrweg-Chromräder ø 95 mm.

	CL 2001 noce-walnut	CL 2001W wengé
	106 x 55 x 85(h) cm	
	2	
	80 Kg	
	595 €	



Foto con OPTIONAL - n. 4 ruote con cuffia ottonata o cromata  
Photos with OPTIONAL - 4 Brass or chrome ball casters  
Photo avec ACCESSOIRES - 4 Roulette à bille en laiton ou chromée  
Abgebildet mit ZUBEHÖR - 4 Messing- oder Chrom-Kugelrolle

+5%

OPTIONAL



## CL 2150



CL 2150

IT Carrelli di servizio in legno. Struttura in legno multistrato di betulla - ripiani in nobilitato - cornice perimetrale e maniglia in legno massello - disponibili nei colori noce e wengé - ruote multidirezionali di serie cromate ø 95 mm.

EN Wooden service trolleys. Birch multi-layered wood structure - melamine shelves - solid wood perimeter frame and handle - available in walnut and wenge colour - standard multidirectional chrome-plated wheels ø 95 mm.

FR Chariots de service en bois. Structure en bouleau multicouche - étagères en bois mélaminé - cadre périmétral et poignée en bois massif - disponible en noyer et wengé - de série roues multidirectionnelles chromées ø 95 mm.

DE Servicewagen aus Holz. Struktur aus Birkenperrholz - Regale aus melaminharzbeschichtetem Birkenholz - Zierrahmen und Griff aus Struktur aus Birkenfurnierholz - Ablagefläche aus Furnierholz - umlaufender Rahmen und Griff aus Massivholz - erhältlich in den Farben Nussbaum und Wenge - serienmäßig mit Mehrweg-Chromräder ø 95 mm.

i	CL 2150 noce-walnut	CL 2150W wengé
↗ cm	86 x 55 x 85(h) cm	
N.	3	
MAX Kg	80 Kg	
	670 €	

## CL 2151



CL 2151W

IT Carrelli di servizio in legno. Struttura in legno multistrato di betulla - ripiani in nobilitato - cornice perimetrale e maniglia in legno massello - disponibili nei colori noce e wengé - ruote multidirezionali di serie cromate ø 95 mm.

EN Wooden service trolleys. Birch multi-layered wood structure - melamine shelves - solid wood perimeter frame and handle - available in walnut and wenge colour - standard multidirectional chrome-plated wheels ø 95 mm.

FR Chariots de service en bois. Structure en bouleau multicouche - étagères en bois mélaminé - cadre périmétral et poignée en bois massif - disponible en noyer et wengé - de série roues multidirectionnelles chromées ø 95 mm.

DE Servicewagen aus Holz. Struktur aus Birkenperrholz - Regale aus melaminharzbeschichtetem Birkenholz - Zierrahmen und Griff aus Struktur aus Birkenfurnierholz - Ablagefläche aus Furnierholz - umlaufender Rahmen und Griff aus Massivholz - erhältlich in den Farben Nussbaum und Wenge - serienmäßig mit Mehrweg-Chromräder ø 95 mm.

i	CL 2151 noce-walnut	CL 2151W wengé
↗ cm	106 x 55 x 85(h) cm	
N.	3	
MAX Kg	80 Kg	
	700 €	

# LP 800



# LP 850

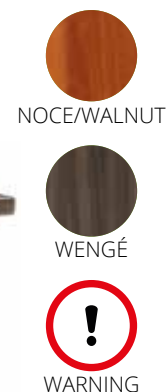

LP 800

IT Carrelli di servizio in legno. Struttura in legno massello - ripiani in nobilitato di betulla - carrelli disponibili nei colori noce o wengé - ruote multidirezionali cromate ø 100 mm.

EN Wooden service trolleys. Solid wood structure - birch multi-layered wood shelves - trolleys available in walnut or wenge colour - multidirectional chrome-plated wheels ø 100 mm.

FR Chariots de service en bois. Structure en bois massif - étagères en bouleau mélaminé - chariot disponible en noyer ou wengé - roues multidirectionnelles chromées ø 100 mm.

DE Servicewagen aus Holz. Struktur aus melaminharzbeschichtetem Birkenholz - Regale aus melaminharzbeschichtetem Birkenholz - Zierrahmen und Griff aus Struktur aus Massivholz- Ablagefläche aus Birkenfurnierholz - erhältlich in den Farben Nussbaum oder Wenge - Mehrweg-Chromräder ø 100 mm.

LP 850W

IT Carrelli di servizio in legno. Struttura in legno massello - ripiani in nobilitato di betulla - carrelli disponibili nei colori noce o wengé - ruote multidirezionali cromate ø 100 mm.

EN Wooden service trolleys. Solid wood structure - birch multi-layered wood shelves - trolleys available in walnut or wenge colour - multidirectional chrome-plated wheels ø 100 mm.

FR Chariots de service en bois. Structure en bois massif - étagères en bouleau mélaminé - chariot disponible en noyer ou wengé - roues multidirectionnelles chromées ø 100 mm.

DE Servicewagen aus Holz. Struktur aus melaminharzbeschichtetem Birkenholz - Regale aus melaminharzbeschichtetem Birkenholz - Zierrahmen und Griff aus Struktur aus Massivholz- Ablagefläche aus Birkenfurnierholz - erhältlich in den Farben Nussbaum oder Wenge - Mehrweg-Chromräder ø 100 mm.

i	LP 800 noce-walnut	LP 800W wengé
cm	81 x 55 x 82(h) cm	
N.	2	
MAX Kg	80 Kg	
	675 €	

i	LP 850 noce-walnut	LP 850W wengé
cm	81 x 55 x 82(h) cm	
N.	3	
MAX Kg	80 Kg	
	800 €	



Foto con OPTIONAL - n. 4 ruote con cuffia ottonata o cromata  
Photos with OPTIONAL - 4 Brass or chrome ball casters  
Photo avec ACCESSOIRES - 4 Roulette à bille en laiton ou chromée  
Abgebildet mit ZUBEHÖR - 4 Messing- oder Chrom-Kugelrolle

+5%

OPTIONAL



34



19

# LP 1000

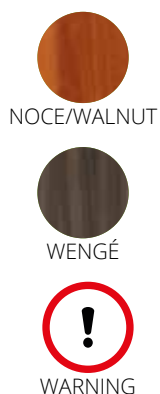

# LP 1050



LP 1000

IT Carrelli di servizio in legno. Struttura in legno massello - ripiani in nobilitato di betulla - carrelli disponibili nei colori noce o wengé - ruote multidirezionali cromate ø 100 mm.

EN Wooden service trolleys. Solid wood structure - birch multi-layered wood shelves - trolleys available in walnut or wenge colour - multidirectional chrome-plated wheels ø 100 mm.

FR Chariots de service en bois. Structure en bois massif - étagères en bouleau mélaminé - chariot disponible en noyer ou wengé - roues multidirectionnelles chromées ø 100 mm.

DE Servicewagen aus Holz. Struktur aus melaminharzbeschichtetem Birkenholz - Regale aus melaminharzbeschichtetem Birkenholz - Zierrahmen und Griff aus Struktur aus Massivholz- Ablagefläche aus Birkenfurnierholz - erhältlich in den Farben Nussbaum oder Wenge - Mehrweg-Chromräder ø 100 mm.

LP 1050W

IT Carrelli di servizio in legno. Struttura in legno massello - ripiani in nobilitato di betulla - carrelli disponibili nei colori noce o wengé - ruote multidirezionali cromate ø 100 mm.

EN Wooden service trolleys. Solid wood structure - birch multi-layered wood shelves - trolleys available in walnut or wenge colour - multidirectional chrome-plated wheels ø 100 mm.

FR Chariots de service en bois. Structure en bois massif - étagères en bouleau mélaminé - chariot disponible en noyer ou wengé - roues multidirectionnelles chromées ø 100 mm.

DE Servicewagen aus Holz. Struktur aus melaminharzbeschichtetem Birkenholz - Regale aus melaminharzbeschichtetem Birkenholz - Zierrahmen und Griff aus Struktur aus Massivholz- Ablagefläche aus Birkenfurnierholz - erhältlich in den Farben Nussbaum oder Wenge - Mehrweg-Chromräder ø 100 mm.

i	LP 1000 noce-walnut	LP 1000W wengé
cm	115 x 55 x 82(h) cm	
N.	2	
MAX Kg	80 Kg	
	710 €	

i	LP 1050 noce-walnut	LP 1050W wengé
cm	115 x 55 x 82(h) cm	
N.	3	
MAX Kg	80 Kg	
	840 €	

20 Carrelli di servizio in legno  
Wooden service trolleys



Foto con OPTIONAL - n. 4 ruote con cuffia ottonata o cromata  
Photos with OPTIONAL - 4 Brass or chrome ball casters  
Photo avec ACCESSOIRES - 4 Roulette à bille en laiton ou chromée  
Abgebildet mit ZUBEHÖR - 4 Messing- oder Chrom-Kugelrolle

## CLC 2012



CLC 2012



## CLC 2013



CLC 2013W



**IT** Carrelli di servizio in legno con cupola. Struttura in legno massello - ripiani in multistrato di betulla - cupola semicircolare in plexiglass apribile su due lati - maniglie di spinta integrate nel piano superiore - ringhiere di contenimento sui piani inferiori- carrelli disponibili nei colori noce, wengè, bianco e nero - ruote multidirezionali di serie cromate ø 95 mm.

**EN** Wooden service trolleys with dome. Solid wood structure - birch multi-layered wood shelves - half-circle dome in Plexiglas that opens on two sides - integrated push handles in the upper shelf - retaining rails on the lower shelves - trolleys available in walnut, wengè, white and black colour - standard multidirectional chrome-plated wheels ø 95 mm.

**FR** Chariots de service en bois avec clochette. Structure en bois massif - étagères en bouleau multicouche - clochette en plexiglas de forme semi-circulaire avec ouverture sur les deux côtés - poignées de poussée intégrées à l'étagère supérieur - profilés de retenue aux étagères inférieures - chariots disponibles en noyer, wengè, blanc et noir - de série roues multidirectionnelles chromées ø 95 mm.

**DE** Servicewagen aus Holz für Kuchen. Massivholzstruktur - Ablageflächen aus Birkensperrholz - zweiseitig aufklappbare, halbrunde Plexiglashaube - Schubgriffe eingebaut an der obersten Fläche - Halterungen in den untersten Etagen - Wagen in Nussbaum, Wenge, Weiß und Schwarz erhältlich - Mehrweg-Chromräder ø 95 mm.

**IT** Carrelli di servizio in legno con cupola. Struttura in legno massello - ripiani in multistrato di betulla - cupola semicircolare in plexiglass apribile su due lati - maniglie di spinta integrate nel piano superiore - ringhiere di contenimento sui piani inferiori- carrelli disponibili nei colori noce, wengè, bianco e nero - ruote multidirezionali di serie cromate ø 95 mm.

**EN** Wooden service trolleys with dome. Solid wood structure - birch multi-layered wood shelves - half-circle dome in Plexiglas that opens on two sides - integrated push handles in the upper shelf - retaining rails on the lower shelves - trolleys available in walnut, wengè, white and black colour - standard multidirectional chrome-plated wheels ø 95 mm.

**FR** Chariots de service en bois avec clochette. Structure en bois massif - étagères en bouleau multicouche - clochette en plexiglas de forme semi-circulaire avec ouverture sur les deux côtés - poignées de poussée intégrées à l'étagère supérieur - profilés de retenue aux étagères inférieures - chariots disponibles en noyer, wengè, blanc et noir - de série roues multidirectionnelles chromées ø 95 mm.

**DE** Servicewagen aus Holz für Kuchen. Massivholzstruktur - Ablageflächen aus Birkensperrholz - zweiseitig aufklappbare, halbrunde Plexiglashaube - Schubgriffe eingebaut an der obersten Fläche - Halterungen in den untersten Etagen - Wagen in Nussbaum, Wenge, Weiß und Schwarz erhältlich - Mehrweg-Chromräder ø 95 mm.

	CLC 2012 noce-walnut	CLC 2012W wengé	CLC 2012B bianco-white	CLC 2012N nero-black
	110 x 55 x 107(h) cm			
	2			
	80 Kg			
	695 €		800 €	

	CLC 2013 noce-walnut	CLC 2013W wengé	CLC 2013B bianco-white	CLC 2013N nero-black
	110 x 55 x 114(h) cm			
	3			
	80 Kg			
	850 €		1000 €	

Carrelli di servizio in legno con cupola  
Wooden service trolleys with dome

**+5%**

OPTIONAL



## CL 2255 - CL 2260



h 58 cm

CL 2255W

IT Carrelli di servizio in legno con cupola. Struttura portante in legno multistrato di betulla - cupola semicircolare in plexiglass apribile su due lati - maniglia di spinta in legno - disponibile nei colori noce e wengé - 2 ripiani - ruote multidirezionali ø 100 mm. Il carrello in foto è con optional pianetto reggiplatto a scomparsa e cassetto portaposate a 3 scomparti .

EN Wooden service trolleys with dome. Load-bearing structure in birch multi-layered wood - half-circle dome in Plexiglas that opens on two sides - wooden push handle - available in walnut and wenge - 2 shelves - multidirectional wheels ø 100 mm. The trolley shown here is equipped with retractable plate support and cutlery drawer with 3 compartments.

FR Chariots de service en bois avec clochette. Structure portante en bouleau multicouche - clochette en plexiglas de forme semi-circulaire avec ouverture sur les deux côtés - poignée en bois - disponible en noyer et wengé - 2 étagères- roues multidirectionnelles ø 100 mm. Le chariot illustré est équipé en option d'un support pour assiettes rétractable et d'un tiroir à couverts à 3 compartiments.

DE Servicewagen aus Holz für Kuchen. Struktur aus Birkensperholz Birkenholz - zweiseitig aufklappbare, halbrunde Plexiglashaube - Schubgriff aus Holz - erhältlich in Nussbaum und Wenge - 2 Einlegeböden - Mehrwegräder ø 100 mm. Der Wagen auf dem Bild ist mit dem ausziehbarem Pfannenträger und Besteckschublade mit 3 Fächern ausgestattet.

i	CL 2255 noce-walnut	CL 2255W wengé	CL 2260 noce-walnut	CL 2260W wengé
cm	86 x 55 x 110(h) cm		106 x 55 x 110(h) cm	
N.	2			
MAX Kg	80 Kg			
	760 €		800 €	

## CL 2350 - CL 2351

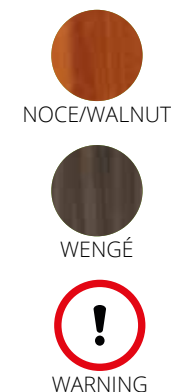

h 58 cm

CL 2350

IT Carrelli di servizio in legno con cupola. Struttura e ripiani in legno nobilitato - cupola semicircolare in plexiglass - maniglia di spinta in legno - disponibile nei colori noce e wengé - ruote multidirezionali 100 mm. Il carrello in foto è con optional pianetto reggiplatto a scomparsa e cassetto portaposate a 3 scomparti.

EN Wooden service trolleys with dome. Load-bearing structure in birch multi-layered wood - half-circle dome in Plexiglas - wooden push handle - available in walnut and wenge - multidirectional wheels ø 100 mm. The trolley shown here is equipped with retractable plate support and cutlery drawer with 3 compartments.

FR Chariots de service en bois avec clochette. Structure portante en bouleau multicouche - clochette en plexiglas de forme semi-circulaire - poignée en bois - disponible en noyer et wengé - roues multidirectionnelles ø 100 mm. Le chariot illustré est équipé en option d'un support pour assiettes rétractable et d'un tiroir à couverts à 3 compartiments.

DE Servicewagen aus Holz für Kuchen. Struktur aus Birkensperholz und Ablageflächen aus melaminharzbeschichtetem Birkenholz - halbrunde Plexiglashaube - Schubgriff aus Holz - erhältlich in Nussbaum und Wenge - Mehrwegräder ø 100 mm. Der Wagen auf dem Bild ist mit dem ausziehbarem Pfannenträger und Besteckschublade mit 3 Fächern ausgestattet.

i	CL 2350 noce-walnut	CL 2350W wengé	CL 2351 noce-walnut	CL 2351W wengé
cm	86 x 55 x 95(h) cm		106 x 55 x 95(h) cm	
N.	2			
MAX Kg	80 Kg			
	780 €		850 €	

+5%

22 Carrelli di servizio in legno con cupola  
Wooden service trolleys with dome

forcar®

# LPC 800 LPC 850



LPC 800



NOCE/WALNUT



WENGÉ



WARNING

h 56 cm

# LPC 1000 LPC 1050



LPC 1050



NOCE/WALNUT



WENGÉ



WARNING

h 75 cm

IT Carrelli di servizio in legno con cupola. Struttura portante in legno massello - ripiani in nobilitato di betulla - cupola semicircolare in plexiglass - ripiani in nobilitato - cornice perimetrale in legno massello - disponibile in colori noce o wengé - modelli a 2 o 3 ripiani - ruote multidirezionali ø 100 mm.

EN Wooden service trolleys with dome. Load-bearing structure in solid wood - shelves in birch laminated wood - half-circle dome in Plexiglas - melamine shelves - solid wood perimeter frame - available in walnut or wengé colour - models with 2 or 3 shelves - multidirectional wheels ø 100 mm.

FR Chariots de service en bois avec clochette. Structure portante en bois massif - étagères en bouleau mélaminé - clochette en plexiglas de forme semi-circulaire - étagères en bouleau stratifié - cadre périmétral en bois massif - disponible en noyer ou wengé - modèles à 2 ou 3 étagères - roues multidirectionnelles ø 100 mm.

DE Servicewagen aus Holz für Kuchen. Struktur aus Massivholz - Ablageflächen aus melaminharzbeschichtetem Birkenholz - halbrunde Plexiglashaube - Ablageflächen aus Melamin - umlaufender Rahmen aus Massivholz - erhältlich in den Farben Nussbaum oder Wenge - Modelle mit 2 oder 3 Einlegeböden - Mehrwegräder ø 100 mm.

IT Carrelli di servizio in legno con cupola. Struttura portante in legno massello - ripiani in nobilitato di betulla - cupola semicircolare in plexiglass - ripiani in nobilitato - cornice perimetrale in legno massello - disponibile in colori noce o wengé - modelli a 2 o 3 ripiani - ruote multidirezionali ø 100 mm.

EN Wooden service trolleys with dome. Load-bearing structure in solid wood - shelves in birch laminated wood - half-circle dome in Plexiglas - melamine shelves - solid wood perimeter frame - available in walnut or wengé colour - models with 2 or 3 shelves - multidirectional wheels ø 100 mm.

FR Chariots de service en bois avec clochette. Structure portante en bois massif - étagères en bouleau mélaminé - clochette en plexiglas de forme semi-circulaire - étagères en bouleau stratifié - cadre périmétral en bois massif - disponible en noyer ou wengé - modèles à 2 ou 3 étagères - roues multidirectionnelles ø 100 mm.

DE Servicewagen aus Holz für Kuchen. Struktur aus Massivholz - Ablageflächen aus melaminharzbeschichtetem Birkenholz - halbrunde Plexiglashaube - Ablageflächen aus Melamin - umlaufender Rahmen aus Massivholz - erhältlich in den Farben Nussbaum oder Wenge - Modelle mit 2 oder 3 Einlegeböden - Mehrwegräder ø 100 mm.

i	LPC 800 noce-walnut	LPC 800W wengé	LPC 850 noce-walnut	LPC 850W wengé
cm	81 x 55 x 108(h) cm			
N.	2		3	
MAX Kg	80 Kg			
	880 €		1000 €	

i	LPC 1000 noce-walnut	LPC 1000W wengé	LPC 1050 noce-walnut	LPC 1050W wengé
cm	115 x 55 x 108(h) cm			
N.	2		3	
MAX Kg	80 Kg			
	920 €		1050 €	

+5%



Foto con OPTIONAL - n. 4 ruote con cuffia ottonata o cromata  
Photos with OPTIONAL - 4 Brass or chrome ball casters  
Photo avec ACCESSOIRES - 4 Roulette à bille en laiton ou chromée  
Abgebildet mit ZUBEHÖR - 4 Messing- oder Chrom-Kugelrolle

OPTIONAL



# CL 2785

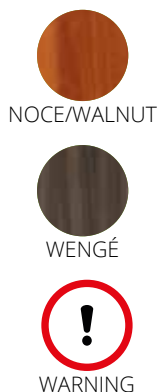

CL 2785

**IT** Carrelli di servizio in legno con cupola. Struttura portante in legno multistrato di betulla - cupola in plexiglass trasparente 150(h) mm - vasca e griglia in acciaio inox - 8 piastre eutettiche refrigeranti - ruote multidirezionali ø 100 mm. Può contenere numero 5 bacinelle GN1/4 con 65(h) mm oppure 5 bacinelle GN1/6 con 65(h) mm.

**EN** Wooden service trolleys with dome. Multi-layered birch wood supporting structure - clear Plexiglas dome 150(h) mm - stainless steel bowl and grid - 8 refrigerant eutectic plates - multidirectional wheels ø 100 mm. It can contain 5 GN1/4 containers 65(h) mm or 5 GN1/6 containers 65(h) mm.

**FR** Chariots de service en bois avec clochette. Structure portante en bouleau multicouche - clochette en plexiglas transparent 150(h) mm - cuve et grille en acier inox - 8 plaques de refroidissement eutectiques - roues multidirectionnelles ø 100 mm. Contient 5 bacs GN1/4 avec 65(h) mm ou 5 bacs GN1/6 avec 65(h) mm.

**DE** Servicewagen aus Holz für Kuchen. Tragkonstruktion aus Birkenperrholz - transparente Plexiglashaube 150(h) mm - Edelstahlbehälter und Grill - 8 Eutektik-Kühlplatten - Mehrwegräder ø 100 mm. Enthält 5 GN1/4 Behälter mit 65(h) mm oder 5 GN1/6 Behälter mit 65(h) mm.

	CL 2785 noce-walnut	CL 2785W wengé
	106 x 55 x 108(h) cm	
	2	
	1440 €	

## Carrelli di servizio in legno con cupola

WOODEN SERVICE TROLLEYS WITH DOME  
CHARIOTS DE SERVICE EN BOIS AVEC CLOCHETTE  
SERVICEWAGEN AUS HOLZ MIT HAUBE

A 100
Pianetto reggiplatte a scomparsa Retractable shelf Étagère à plateaux encastrée Verdeckte Tablettablage
50 €
A 200
Cassetto portaposate a 3 scomparti Cutlery drawer with 3 compartments Tiroir à couverts avec 3 compartiments Besteckschublade mit 3 Fächern
85 €

+5%

+5%



# CL 2751 - CL 2752



CL 2751

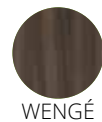

↑ h 35 cm ↓

IT Carrelli Flambè. Struttura portante in legno multistrato di betulla monocolpo - rivestimento in legno massello di castagno - piano di cottura in acciaio inox - ribaltina laterale - maniglia di spinta in acciaio cromato - portabottiglie in acciaio cromato - 2 cassetti - vano porta bombola da 2 kg - ruote multidirezionali ø 100 mm.

EN Flambé trolleys. Load-bearing structure in one-piece multi-layered wood - solid chestnut wood lining - stainless steel cooking plate - side folding panel - chrome-plated steel push handle - chrome-plated steel bottle rack - 2 drawers - 2 kg gas bottle compartment - multidirectional wheels ø 100 mm.

FR Chariots Flambé. Structure portante en bois de bouleau multicouche à structure monocoque - revêtement en châtaignier massif - plaque de cuisson en acier inox - volet latéral - poignée de poussée en acier chromé - porte-bouteille en acier chromé - 2 tiroirs - compartiment porte-bouteille de 2 kg - roues multidirectionnelles ø 100 mm.

DE Flambè-Wagen. Monoblock Struktur aus Birkensperholz - Verkleidung aus massivem Kastanienholz - Kochplatte aus Edelstahl - Seitenklappe - Schubgriff aus verchromtem Stahl - Flaschenständer aus verchromtem Stahl - 2 Schubladen - 2 kg Gasflaschenfach - Mehrwegräder ø 100 mm.

# CL 2750



CL 2750W

↑ h 35 cm ↓

**+5%**

	CL 2751 noce-walnut	CL 2751W wengé	CL 2752 noce-walnut	CL 2752W wengé
	107/145 x 58 x 91(h) cm			
	107/145 x 58 x 91(h) cm			
	1 piastra - 1 fuoco 1 plate - 1 burner		2 piastre a 1 fuoco separato 2 plate 1 separate burner	
	35 Kg		35 Kg	
	1280 €		1520 €	

	CL 2750 noce-walnut	CL 2750W wengé
	107/145 x 58 x 91(h) cm	
	107/145 x 58 x 91(h) cm	
	1 piastra - 2 fuochi 1 plate - 2 burners	
	35 Kg	
	1400 €	



Foto con OPTIONAL - n. 4 ruote con cuffia ottonata o cromata  
Photos with OPTIONAL - 4 Brass or chrome ball casters  
Photo avec ACCESSOIRES - 4 Roulette à bille en laiton ou chromée  
Abgebildet mit ZUBEHÖR - 4 Messing- oder Chrom-Kugelrolle

# CF 1200 - CF 1201 CF 1202



h 35 cm

CF 1200

IT Carrelli Flambè. Struttura portante in legno nobilitato - piano di cottura in acciaio inox con bruciatore regolabile - ribaltina laterale - maniglia di spinta in acciaio cromato - portabottiglie in acciaio cromato - 1 cassetto - 1 sportello vano porta bombola da 3 Kg - ruote multidirezionali ø 100 mm.

EN Flambé trolleys. Load-bearing structure in laminated wood - stainless steel cooking plate with adjustable burner - side folding panel - chrome-plated steel push handle - chrome-plated steel bottle rack - 1 drawer - 3 kg gas bottle compartment - multidirectional wheels ø 100 mm.

FR Chariots Flambé. Structure portante en bois mélaminé - plaque de cuisson en acier inox avec brûleur réglable - volet latéral - poignée de poussée en acier chromé - porte-bouteille en acier chromé - 1 tiroir - compartiment avec porte pour bouteille de 3 kg - roues multidirectionnelles ø 100 mm.

DE Flambè-Wagen. Struktur aus melaminharzbeschichtetem Holz - Kochplatte aus Edelstahl mit einstellbarem Brenner - Schubgriff aus verchromtem Stahl - Flaschenständeraus verchromtem Stahl - 1 Schublade - 3 Kg Gasflaschenfach - Mehrwegräder ø 100 mm.

+5%

## Carrelli Flambé Flambè Trolleys

AB2 CL2750-51-52	AB3 CF1200-1201-1202
Bombola gas 2 Kg. (vuota) Gas bottle 2 kg (empty) Bouteille de gaz 2 kg (vide) Gasflasche 2 kg (leer)	Bombola gas 3 Kg. (vuota) Gas bottle 3 kg (empty) Bouteille de gaz 3 kg (vide) Gasflasche 3 kg (leer)



60 €



65 €

i	CF 1200 noce-walnut	CF 1200W wengé	CF 1201 noce-walnut	CF 1201W wengé
cm	115 x 55 x 108(h) cm			
	1 piastra - 1 fuoco 1 plate - 1 burner		1 piastra - 2 fuochi 1 plate - 2 burners	
MAX Kg	35 Kg			
	990 €		1100 €	

i	CF 1202 noce-walnut	CF 1202W wengé
cm	107/145 x 58 x 85(h) cm	
	2 piastre a 1 fuoco separato 2 plate 1 separate burner	
MAX Kg	35 Kg	
	1160 €	



Foto con OPTIONAL - n. 4 ruote con cuffia ottonata o cromata  
Photos with OPTIONAL - 4 Brass or chrome ball casters  
Photo avec ACCESSOIRES - 4 Roulette à bille en laiton ou chromée  
Abgebildet mit ZUBEHÖR - 4 Messing- oder Chrom-Kugelrolle

## ML 3000 SS

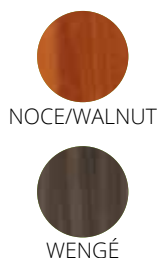

## ML 3170SS ML 3170ST



ML 3000 SS

**IT** Mobili di servizio bassi doppi - struttura e pannelli in nobilitato con bordi protetti da profilo in gomma - 2 cassetti portaposate di cui 1 con separatore - 2 sportelli - disponibile in colore noce e wengé - ruote multidirezionali ø 50 mm.

**EN** Low double service cabinets - structure and panels in melamine with edges protected by rubber profile - 2 cutlery drawers, 1 with separator - 2 doors - available in walnut and wenge colour - multidirectional wheels ø 50 mm.

**FR** Meubles bas de service double - structure et panneaux en mélaminé avec bords en caoutchouc - 2 tiroirs à couverts dont 1 avec séparateur - 2 portes - disponible en noyer et wengé - roues multidirectionnelles ø 50 mm.

**DE** Niedrige Doppelservicemöbel - Struktur und Blenden aus Melamin mit Gummikantenschutz - 2 Besteckschubladen, davon 1 mit Trennwand - 2 Türen - erhältlich in Nussbaum und Wenge - Mehrwegräder ø 50 mm.

ML 3170 SS

**IT** Mobili di servizio alti doppi - struttura e pannelli in nobilitato con bordi protetti da profilo in gomma - sportello superiore in plexiglass fumè - 2 cassetti portaposate di cui 1 con separatore - 2 sportelli (SS) oppure 1 sportello e 1 tramoggia (ST) - disponibile in colore noce - ruote multidirezionali ø 50 mm.

**EN** High double service cabinets - structure and panels in melamine with edges protected by a rubber profile - smoky grey Plexiglas upper door - 2 cutlery drawers, 1 with separator - 2 doors (SS) or 1 door and 1 hopper (ST) - available in walnut colour - multidirectional wheels ø 50 mm.

**FR** Meubles hauts de service double - structure et panneaux en mélaminé avec bords en caoutchouc - porte supérieure en plexiglas fumé - 2 tiroirs à couverts dont 1 avec séparateur - 2 portes (SS) ou 1 porte et 1 trémie (ST) - disponible en noyer - roues multidirectionnelles ø 50 mm.

**DE** Hohe Doppelservicemöbel - Struktur und Blenden aus Melamin mit Gummikantenschutz - obere Tür aus dunklem Plexiglas - 2 Besteckschubladen, davon 1 mit Trennwand - 2 Türen (SS) oder 1 Tür und 1 Trichter (ST) - erhältlich in Nussbaum - Mehrwegräder ø 50 mm.

	ML 3000 SS noce-walnut	ML 3000 SSW wengé
	95 x 49 x 99(h) cm	
	2 sportelli - 2 cassetti 2 doors - 2 drawers	
	640 €	

**+5%**

	ML 3170 SS noce-walnut	ML 3170 ST noce-walnut
	95 x 49 x 144(h) cm	
	2 sportelli in plexiglas fumè 2 sportelli - 2 cassetti 2 door in smoky grey Plexiglas 2 doors - 2 drawers	2 sportelli in plexiglas fumè 1 sportello - 1 tramoggia - 2 cassetti 1 door - 1 hopper - 2 drawers
	1000 €	1100 €

Mobili di servizio in legno  
Wooden serving furniture

OPTIONAL



# ML 3150ST ML 3100SS

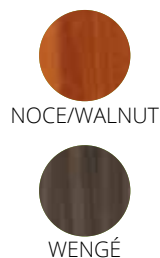

ML 3150 STW

# ML 3050S



IT Mobili di servizio alti doppi - struttura e pannelli in nobilitato con bordi protetti da profilo in gomma - alzatina con 2 mensole - 2 cassetti portaposate di cui 1 con separatore - 2 sportelli (SS) oppure 1 sportello e 1 tramoggia (ST) - disponibile in colore noce e wengé - ruote multidirezionali ø 50 mm.

EN High double service cabinets - structure and panels in melamine with edges protected by rubber profile - backsplash with 2 shelves - 2 cutlery drawers, 1 with separator - 2 doors (SS) or 1 door and 1 hopper (ST) - available in walnut and wenge colour - multidirectional wheels ø 50 mm.

FR Meubles hauts de service double - structure et panneaux en mélaminé avec bords en caoutchouc - dossier avec 2 étagères - 2 tiroirs à couverts dont 1 avec séparateur - 2 portes (SS) ou 1 porte et 1 trémie (ST) - disponible en noyer et wengé - roues multidirectionnelles ø 50 mm.

DE Hohe Doppelservicemöbel - Struktur und Blenden aus Melamin mit Gummikantenschutz - Rückwand mit 2 Regalen - 2 Besteckschubladen, davon 1 mit Trennwand - 2 Türen (SS) oder 1 Tür und 1 Trichter (ST) - erhältlich in Nussbaum und Wenge - Mehrwegräder ø 50 mm.

IT Mobile di servizio alto singolo - struttura e pannelli in nobilitato con bordi protetti da profilo in gomma - alzatina con 2 mensole - 1 cassetto portaposate con separatore - 1 sportello - disponibile in colore noce - ruote multidirezionali ø 50 mm.

EN Low single service cabinet - structure and panels in melamine with edges protected by rubber profile - backsplash with 2 shelves - 1 cutlery drawer with separator - 1 door - available in walnut colour - multidirectional wheels ø 50 mm.

FR Meuble bas de service simple - structure et panneaux en mélaminé avec bords en caoutchouc - dossier avec 2 étagères - 1 tiroir à couverts avec séparateur - 1 porte - disponible en noyer et wengé - roues multidirectionnelles ø 50 mm.

DE Niedrige Doppelservicemöbel - Struktur und Blenden aus Melamin mit Gummikantenschutz - Rückwand mit 2 Regalen - 1 Besteckschublade mit Trennwand - 1 Tür - erhältlich in Nussbaumfarbe - Mehrwegräder ø 50 mm.

	ML 3150 ST noce-walnut	ML 3150 STW wengé	ML 3100 SS noce-walnut	ML 3100 SSW wengé
	95 x 49 x 144(h) cm			
	1 sportello - 1 tramoggia - 2 cassetti 1 door - 1 hopper - 2 drawers		2 sportelli - 2 cassetti 2 doors - 2 drawers	
	900 €		800 €	

	ML 3050 S noce-walnut
	45 x 49 x 144(h) cm
	1 sportello - 1 cassetto 1 door - 1 drawer
	710 €

+5%

# ML 3202SS



ML 3202 SS

IT Mobili di servizio in legno. Mobili di servizio bassi doppi - struttura e pannelli in nobilitato - 2 cassetti portaposate di cui 1 con separatore - 2 sportelli - disponibile in colore noce, wengé e rovere - ruote multidirezionali ø 50 mm.

EN Wooden service cabinets. Low double service cabinets - melamine structure and panels - 2 cutlery drawers, 1 with separator - 2 doors - available in walnut, wenge and oak colour - multidirectional wheels ø 50 mm.

FR Meubles de service en bois. Meubles bas de service double - structure et panneaux en mélaminé - 2 tiroirs à couverts dont 1 avec séparateur - 2 portes - disponible en noyer, wengé et chêne - roues multidirectionnelles ø 50 mm.

DE Servicemöbel aus Holz. Niedrige Doppelservicemöbel - Struktur und Blenden aus Melamin - 2 Besteckschubladen, davon 1 mit Trennwand - 2 Türen - erhältlich in Nussbaum, Wenge und Eichenfarbe - Mehrwegräder ø 50 mm.

	ML 3202 SSN noce-walnut	ML 3202 SSW wengé	ML 3202 SS rovere-durmast
	90 x 48 x 95(h) cm		
	2 sportelli - 2 cassetti 2 doors - 2 drawers		
	670 €		

+5%

# ML 3212SS



ML 3212 SS

ML 3212 SSW

IT Mobili di servizio alti doppi - struttura e pannelli in nobilitato - 2 cassetti portaposate di cui 1 con separatore - 2 sportelli - disponibile in colore noce, wengé e rovere - ruote multidirezionali ø 50 mm.

EN High double service cabinets - melamine structure and panels - 2 cutlery drawers, 1 with separator - 2 doors - available in walnut, wenge and oak colour - multidirectional wheels ø 50 mm.

FR Meubles hautes de service double - structure et panneaux en mélaminé - 2 tiroirs à couverts dont 1 avec séparateur - 2 portes - disponible en noyer, wengé et chêne - roues multidirectionnelles ø 50 mm.

DE Hohe Doppelservicemöbel - Struktur und Blenden aus Melamin - 2 Besteckschubladen, davon 1 mit Trennwand - 2 Türen - erhältlich in Nussbaum, Wenge und Eichenfarbe - Mehrwegräder ø 50 mm.

	ML 3212 SSN noce-walnut	ML 3212 SSW wengé	ML 3212 SS rovere-durmast
	90 x 48 x 155(h) cm		
	2 sportelli - 2 cassetti 2 doors - 2 drawers		
	910 €		

Mobili di servizio in legno  
Wooden serving furniture

OPTIONAL



## ML 3200S



ML 3200 SW

## ML 3210S



ML 3210 SW

IT Mobili di servizio singoli bassi - struttura e pannelli in nobilitato - 1 cassetto portaposate con separatore - 1 sportello - disponibile in colore noce, wengé e rovere - ruote multidirezionali ø 50 mm.

EN High single service cabinet - melamine structure and panels - 1 cutlery drawer with separator - 1 door - available in walnut, wenge and oak colour - multidirectional wheels ø 50 mm.

FR Meubles bas de service simple - structure et panneaux en mélaminé - 1 tiroir à couverts avec séparateur - 1 porte - disponible en noyer, wengé et chêne - roues multidirectionnelles ø 50 mm.

DE Niedrige Einzelne Servicemöbeln - Struktur und Blenden aus Melamin - 1 Besteckschublade mit Trennwand - 1 Tür - erhältlich in Nussbaum, Wenge und Eichenfarbe - Mehrwegräder ø 50 mm.

IT Mobili di servizio singoli alti - struttura e pannelli in nobilitato - 1 cassetto portaposate con separatore - 1 sportello - disponibile in colore noce, wengé e rovere - ruote multidirezionali ø 50 mm.

EN High single service cabinet - melamine structure and panels - 1 cutlery drawer with separator - 1 door - available in walnut, wenge and oak colour - multidirectional wheels ø 50 mm.

FR Meubles hautes de service simple - structure et panneaux en mélaminé - 1 tiroir à couverts avec séparateur - 1 porte - disponible en noyer, wengé et chêne - roues multidirectionnelles ø 50 mm.

DE Hohe Einzelne Servicemöbeln - Struktur und Blenden aus Melamin - 1 Besteckschublade 1 mit Trennwand - 1 Tür - erhältlich in Nussbaum, Wenge und Eichenfarbe - Mehrwegräder ø 50 mm.

	ML 3200 SN noce-walnut	ML 3200 SW wengé	ML 3200 S rovere-durmast
	45 x 48 x 95(h) cm		
	1 sportello - 1 cassetto 1 door - 1 drawer		
	480 €		

+5%

	ML 3210 SN noce-walnut	ML 3210 SW wengé	ML 3210 S rovere-durmast
	45 x 48 x 155(h) cm		
	1 sportello - 1 cassetto 1 door - 1 drawer		
	700 €		

# ML 3204SS



ML 3204 SS

IT Mobili di servizio bassi tripli - struttura e pannelli in nobilitato - 3 cassetti portaposate di cui 2 con separatore - 2 sportelli - 1 vano interno - disponibile in colore noce, wengé e rovere - ruote multidirezionali ø 50 mm.

EN Low triple service cabinets - melamine structure and panels - 3 cutlery drawers, 2 with separator - 2 doors - 1 internal compartment - available in walnut, wenge and oak colour - multidirectional wheels ø 50 mm.

FR Meubles bas de service triple - structure et panneaux mélaminés - 3 tiroirs à couverts, dont 2 avec séparateur - 2 portes - 1 compartiment intérieur - disponible en couleur noyer, wengé et chêne - roues multidirectionnelles ø 50 mm.

DE Niedrige Trippelservicemöbel - Struktur und Blenden aus Melamin - 3 Besteckschubladen, davon 2 mit Trennwand - 2 Türen - 1 Innenfach - erhältlich in Nussbaum, Wenge und Eichenfarbe - Mehrwegräder ø 50 mm.

# ML 3214SS



ML 3214 SSW

IT Mobili di servizio alti tripli - struttura e pannelli in nobilitato - 3 cassetti portaposate di cui 2 con separatore - 2 sportelli - 1 vano interno - disponibile in colore noce, wengé e rovere - ruote multidirezionali ø 50 mm.

EN High triple service cabinets - melamine structure and panels - 3 cutlery drawers, 3 with separator - 2 doors - 1 internal compartment - available in walnut, wenge and oak colour - multidirectional wheels ø 50 mm.

FR Meubles de service hautes triple - structure et panneaux en mélaminé - 3 tiroirs à couverts dont 2 avec séparateur - 2 portes - 1 compartiment intérieur - disponible en noyer, wengé et chêne - roues multidirectionnelles ø 50 mm.

DE Hohe Trippelservicemöbel - Struktur und Blenden aus Melamin - 3 Besteckschubladen, davon 2 mit Trennwand - 2 Türen - 1 Innenfach - erhältlich in Nussbaum, Wenge und Eichenfarbe - Mehrwegräder ø 50 mm.

	ML 3204 SSN noce-walnut	ML 3204 SSW wengé	ML 3204 SS rovere-durmast
	136 x 48 x 95(h) cm		
	2 sportelli - 3 cassetti - 1 vano interno 2 doors - 3 drawers - 1 internal compartment		
	870 €		

+5%

	ML 3214 SSN noce-walnut	ML 3214 SSW wengé	ML 3214 SS rovere-durmast
	136 x 48 x 155(h) cm		
	2 sportelli - 3 cassetti - 1 vano interno 2 doors - 3 drawers - 1 internal compartment		
	1160 €		

Mobili di servizio in legno  
Wooden serving furniture

OPTIONAL



## ML 3212 SSP



## ML 3214 SSP



ML 3212 SSPW

ML 3214 SSPN

IT Mobili di servizio alti doppi - struttura e pannelli in nobilitato - struttura reggi pensili in acciaio plastificato - 2 pensili - 2 cassetti portaposate di cui 1 con separatore - 2 sportelli - disponibile in colore noce e wengé - ruote multidirezionali  $\varnothing$  50 mm. Optional tramoggia A270-A270W.

IT Mobili di servizio alti tripli - struttura e pannelli in nobilitato - struttura reggi pensili in acciaio plastificato - 3 pensili - 3 cassetti portaposate di cui 2 con separatore - 2 sportelli - 1 vano interno - disponibile in colore noce e wengé - ruote multidirezionali  $\varnothing$  50 mm.

EN High double service cabinets - melamine structure and panels - plastic-coated steel wall cabinets support structure - 2 wall cabinets - 2 cutlery drawers, 1 with separator - 2 doors - available in walnut and wenge colour - multidirectional wheels  $\varnothing$  50 mm. Optional hopper A270-A270W.

EN High triple service cabinets - melamine structure and panels - plastic-coated steel wall cabinets support structure - 3 wall cabinets - 3 cutlery drawers, 2 with separator - 2 doors - 1 internal compartment - available in walnut and wenge colour - multidirectional wheels  $\varnothing$  50 mm.

FR Meubles hautes de service double - structure et panneaux en mélaminé - 2 tiroirs à couverts dont 1 avec séparateur - 2 portes - disponible en noyer, wengé et chêne - roues multidirectionnelles  $\varnothing$  50 mm. Trémie A270-A270W en option.

FR Meubles de service hautes triple - structure et panneaux en mélaminé - structure de supports pour meubles à mur en acier plastifié - 3 tiroirs à couverts dont 2 avec séparateur - 2 portes - 1 compartiment intérieur - disponible en noyer et wengé - roues multidirectionnelles  $\varnothing$  50 mm.

DE Hohe Servicemöbel - Struktur und Blenden aus Melamin - kunststoffbeschichtete Stahl-Halterungen - 2 Hängeschränke - 2 Besteckschubladen, davon 1 mit Trennwand - 2 Türen - erhältlich in Nussbaum und Wenge - Mehrwegräder  $\varnothing$  50 mm. Auf Wunsch Trichter A270-A270W.

DE Hohe Trippelservicemöbel - Struktur und Blenden aus Melamin - kunststoffbeschichtete Stahl-Halterungen - 3 Hängeschränke - 3 Besteckschubladen, davon 2 mit Trennwand - 2 Türen - 1 Innenfach - erhältlich in Nussbaum und Wenge - Mehrwegräder  $\varnothing$  50 mm.

i	ML 3212 SSPN noce-walnut	ML 3212 SSPW wengé
↗ cm	92 x 48 x 153(h) cm	
	2 pensili - 2 sportelli - 2 cassetti 2 wall cabinets - 2 doors - 2 drawers	
	1140 €	

i	ML 3214 SSPN noce-walnut	ML 3214 SSPW wengé
↗ cm	137 x 48 x 153(h) cm	
	3 pensili - 2 sportelli - 3 cassetti - 1 vano interno 3 wall cabinets - 2 doors - 3 drawers - 1 internal compartment	
	1400 €	

+5%





Su tutti i modelli  
On all models

CL - CLP - CLC

n. 4 ruote con cuffia ottonata o cromata  
4 Brass or chrome ball casters  
4 Roulette à bille en laiton ou chromée  
4 Messing- oder Chrom-Kugelrolle



140 €

Solo per mobili  
di servizio  
Service furniture only

Applicazione tramoggia per mobili  
overprice for furniture hopper  
surprix de trémie pour meubles  
Preiszuschlag für Möbeltrichter

A 250	A 250W	A 260	A 270
ML 3000 SS ML 3170 SS ML 3100 SS ML 3050 S	ML 3000SSW ML 3170SSW ML 3100SSW	ML 3200SS ML 3202SS ML 3210S ML 3212SS ML 3204SS ML 3210SN ML 3212SSPN	ML 3214SSPN ML 3214SSPW
130 €			

Carrelli di servizio in legno  
Wooden service trolleys

Espositore di vini - portabottiglie - struttura in legno  
Wine display rack - bottle rack - wooden frame  
Présentoir à vin - porte-bouteilles - structure en bois  
Weinständer - Flaschenregal - Holzstruktur

	A 1250 noce-walnut	A 1250W wengé	A 1260 noce-walnut	A 1260W wengé
Mod.	CL 70 - CL 2000 CL 2150	CL 70W - CL 2000W CL 2150W	CL 90 - CL 2001 CL 2151	CL 90W - CL 2001W CL 2151W
↗ cm	68 x 46 x 19(h) mm		88 x 46 x 19(h) mm	
	190 €		210 €	



NOCE/WALNUT WENGÉ

Espositore di liquori - portabottiglie - struttura in legno - ringhiere in acciaio inox  
Wine display rack, bottle rack, wooden frame, stainless steel railings  
Présentoir à vin, porte-bouteilles, structure en bois, barres de protection en acier inox  
Weinständer - Flaschenregal - Holzstruktur, Edelstahlleisten

	A 1270 noce-walnut	A 1270W wengé	A 1280 noce-walnut	A 1280W wengé
Mod.	CL 70 - CL 2000 CL 2150	CL 70W - CL 2000W CL 2150W	CL 90 - CL 2001 CL 2151	CL 90W - CL 2001W CL 2151W
↗ cm	68 x 46 x 37(h) mm		88 x 46 x 37(h) mm	
	200 €		220 €	



NOCE/WALNUT WENGÉ

+5%

## Carrelli di servizio in legno Wooden service trolleys

Espositore ghiacciaia. Struttura in legno con vasca e griglia in acciaio inox - cupola plexiglass - provvisto di 8 contenitori eutectici.

Icebox display. Wooden structure with stainless steel bowl and grill - Plexiglas dome - equipped with 8 eutectic containers.

Présentoir glacière. Structure en bois avec cuve et grille en acier inox - clochette en plexiglas - équipé de 8 conteneurs eutectiques.

Gefrierfachvitrine. Holzstruktur mit Edelstahlwanne und Gitter - Plexiglashaube - ausgestattet mit 8 eutektischen Behältern.



	A 1290 noce-walnut	A 1290W wengé
Mod.	CL90 - CL2001 CL2151	CL90W - CL2001W CL2151W
 cm	90 x 48,5 x 23(h) mm	
	720 €	

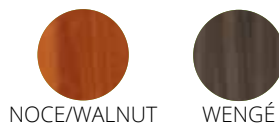

NOCE/WALNUT

WENGÉ

+5%

Vetrinetta con struttura in legno e cupola in plexiglass

Display with wooden structure and Plaxiglas dome.

Présentoir avec structure en bois et clochette en plexiglas.

Vitrine mit Holzstruktur und Plexiglashaube.



	A 1299 noce-walnut	A 1299W wengé	A 1298 noce-walnut	A 1298W wengé
Mod.	CL 70 - CL 2000 CL 2150	CL 70W - CL 2000W CL 2150W	CL90 - CL2001 CL2151	CL90W - CL2001W CL2151W
 cm	70 x 50 x 22(h) mm		90 x 50 x 22(h) mm	
	310 €		330 €	



# Carrelli di servizio in acciaio inox

STAINLESS STEEL SERVICE TROLLEYS  
CHARIOTS DE SERVICE EN ACIER INOX  
SERVICEWAGEN AUS EDELSTAHL

## CA 1000 - CA 1001



CA 1000W



## CA 1050 - CA 1051



CA 1050



IT Struttura tubolare 20x20 mm in acciaio inox **AISI 304** - ripiani in nobilitato con cornice perimetrale in acciaio inox **AISI 304** - paracolpi in gomma - ruote multidirezionali ø 125 mm.

EN Tubular structure 20x20 mm in stainless steel **AISI 304** - melamine shelves with perimeter frame in stainless steel **AISI 304** - rubber shock absorber - multidirectional wheels ø 125 mm.

FR Structure tubulaire 20x20 mm en acier inox **AISI 304** - étagères en mélaminé avec cadre périmétral en acier inox **AISI 304** - butoirs en caoutchouc - roues multidirectionnelles ø 125 mm.

DE Rohrrahmen 20x20 mm aus Edelstahl **AISI 304** - Ablageflächen aus Melamin mit umlaufendem Rahmen aus Edelstahl **AISI 304** - Gummistoßschutz - Mehrwegräder ø 125 mm.

IT Struttura tubolare 20x20 mm in acciaio inox **AISI 304** - ripiani in nobilitato con cornice perimetrale in acciaio inox **AISI 304** - paracolpi in gomma - ruote multidirezionali ø 125 mm.

EN Tubular structure 20x20 mm in stainless steel **AISI 304** - shelves in melamine with perimeter frame in stainless steel **AISI 304** - rubber shock absorber - multidirectional wheels ø 125 mm.

FR Structure tubulaire 20x20 mm en acier inox **AISI 304** - étagères en mélaminé avec cadre périmétral en acier inox **AISI 304** - butoirs en caoutchouc - roues multidirectionnelles ø 125 mm.

DE Rohrrahmen 20x20 mm aus Edelstahl **AISI 304** - Ablageflächen aus Melamin mit umlaufendem Rahmen aus Edelstahl **AISI 304** - Gummistoßschutz - Mehrwegräder ø 125 mm.

i	CA 1000 noce-walnut	CA 1000W wengé	CA 1001 noce-walnut	CA 1001W wengé
cm	83 x 57 x 97(h) cm		103 x 57 x 97(h) cm	
N.	2			
mm	72,4 x 50 cm		92,4 x 50 cm	
MAX Kg	60 Kg			
	260 €		270 €	

+5%

i	CA 1050 noce-walnut	CA 1050W wengé	CA 1051 noce-walnut	CA 1051W wengé
cm	83 x 57 x 97(h) cm		103 x 57 x 97(h) cm	
N.	3			
mm	72,4 x 50 cm		92,4 x 50 cm	
MAX Kg	60 Kg			
	340 €		360 €	

Carrelli di servizio in acciaio inox e ripiani in nobilitato  
Stainless steel service trolleys and melamine shelves

OPTIONAL



# CA 1070 CA 1071



IT Struttura tubolare 20x20 mm in acciaio inox **AISI 304** - ripiani in nobilitato con cornice perimetrale in acciaio inox **AISI 304** - paracolpi in gomma - ruote multidirezionali  $\varnothing$  125 mm.

EN Tubular structure 20x20 mm in stainless steel **AISI 304** - shelves in melamine with perimeter frame in stainless steel **AISI 304** - rubber shock absorber - multidirectional wheels  $\varnothing$  125 mm.

FR Structure tubulaire 20x20 mm en acier inox **AISI 304** - étagères en mélaminé avec cadre périmétral en acier inox **AISI 304** - butoirs en caoutchouc - roues multidirectionnelles  $\varnothing$  125 mm.

DE Rohrrahmen 20x20 mm aus Edelstahl **AISI 304** - Ablageflächen aus Melamin mit umlaufendem Rahmen aus Edelstahl **AISI 304** - Gummistoßschutz - Mehrwegräder  $\varnothing$  125 mm.

	CA 1070 noce-walnut	CA 1071 noce-walnut
	83 x 57 x 172(h) cm	103 x 57 x 172(h) cm
	4	
	72,4 x 50 cm	92,4 x 50 cm
	60 Kg	
	450 €	470 €

**+5%**

## Optional

### A 512

Ruote con freno - Wheels with catch  
Roues avec frein - Räder mit Bremse

CA 1000-1050-1070-1071  
CA 1380-81-82-83-84-85-86-87-88-89-90-91-96  
CA 1410-11-12-13-14-15-16-17-24-25-26-27

8 € cad./each

### A 514

Ruote con freno - Wheels with catch  
Roues avec frein - Räder mit Bremse

CA 1392P-93P-94P-95P

10 € cad./each

### A 517

Ruote con freno - Wheels with catch  
Roues avec frein - Räder mit Bremse

CA 1430-31-32-33

15 € cad./each



A 512

A 514

CA 1380  
CA 1381

CA 1382  
CA 1383

CA 1384  
CA 1385



IT Struttura tubolare 20x20 mm in acciaio inox **AISI 304** - ripiani in acciaio inox **AISI 304** piegati, satinati, insonorizzati - paracolpi in gomma - ruote multidirezionali  $\varnothing$  125 mm.

FR Structure tubulaire 20x20 mm en acier inox **AISI 304** - étagères en acier inox **AISI 304** pliées, satinées, insonorisées - butoirs en caoutchouc - roues multidirectionnelles  $\varnothing$  125 mm.

EN Tubular structure 20x20 mm in stainless steel **AISI 304** - **AISI 304** stainless steel folded, satin-finished, soundproofed shelves - rubber shock absorber - multidirectional wheels  $\varnothing$  125 mm.

DE Rohrrahmen 20x20 mm aus Edelstahl **AISI 304** - Gebogene, Schallgedämmte Ablageflächen aus Edelstahl **AISI 304** mit satiniertes Oberfläche - Gummistoßschutz - Mehrwegräder  $\varnothing$  125 mm.

	CA 1380	CA 1381	CA 1382	CA 1383	CA 1384	CA 1385
						
	91 x 57 x 172(h) cm	111 x 57 x 172(h) cm	91 x 57 x 96(h) cm	111 x 57 x 96(h) cm	91 x 57 x 96(h) cm	111 x 57 x 96(h) cm
	4		2		3	
	80 x 50 cm	100 x 50 cm	80 x 50 cm	100 x 50 cm	80 x 50 cm	100 x 50 cm
	80 Kg		80 Kg		80 Kg	
	480 €	510 €	260 €	285 €	340 €	375 €

Carrelli di servizio in acciaio inox  
Stainless steel service trolleys

+5%

CA 1390  
CA 1391

CA 1410  
CA 1411

CA 1412 - CA 1413  
CA 1414



CA 1390



CA 1410



CA 1412

IT Struttura tubolare  $\varnothing$  25 mm in acciaio inox **AISI 304** - ripiani in acciaio inox **AISI 304**, stampati in forma di vassoio con bordi arrotondati e alto spessore, insonorizzati e con finitura satinata - paracolpi in gomma - ruote multidirezionali  $\varnothing$  125 mm.

FR Structure tubulaire  $\varnothing$  25 mm en acier inox **AISI 304** - étagères en acier inox **AISI 304**, moulées en forme de plateau à bords arrondis et de grande épaisseur, insonorisées et satinées - butoirs en caoutchouc - roues multidirectionnelles  $\varnothing$  125 mm.

EN Tubular structure  $\varnothing$  25 mm in stainless steel **AISI 304** - **AISI 304** stainless steel shelves, tray-shaped with rounded edges and high thickness, soundproofed and with satin finish - rubber shock absorber - multidirectional wheels  $\varnothing$  125 mm.

DE Rohrrahmen  $\varnothing$  25 mm aus Edelstahl **AISI 304** - Schallgedämmte Ablageflächen aus Edelstahl **AISI 304**, Tablett förmig bedruckt mit abgerundeten Kanten und satiniertes Oberfläche - Gummistoßschutz-Mehrwegräder  $\varnothing$  125 mm.

	CA 1390	CA 1391	CA 1410	CA 1411	CA 1412	CA 1413	CA 1414
	90 x 60 x 94(h) cm	110 x 60 x 94(h) cm	90 x 60 x 104(h) cm	110 x 60 x 104(h) cm	100 x 70 x 94(h) cm	110 x 70 x 94(h) cm	128 x 70 x 94(h) cm
	2		3		2		
	80 x 50 cm	100 x 50 cm	80 x 50 cm	100 x 50 cm	90 x 60 cm	100 x 60 cm	120 x 60 cm
	100 Kg		100 Kg		100 Kg		
	250 €	260 €	320 €	340 €	290 €	305 €	390 €



Carrelli di servizio in acciaio inox  
Stainless steel service trolleys

+5%

forcar®



CA 1415 - CA 1416  
CA 1417



CA 1415

CA 1424  
CA 1425



CA 1424

CA 1426  
CA 1427



CA 1426

IT Struttura tubolare  $\varnothing$  25 mm in acciaio inox **AISI 304** - ripiani in acciaio inox **AISI 304**, stampati in forma di vassoio con bordi arrotondati e alto spessore, insonorizzati e con finitura satinata - paracolpi in gomma - ruote multidirezionali  $\varnothing$  125 mm.

EN Tubular structure  $\varnothing$  25 mm in stainless steel **AISI 304** - **AISI 304** stainless steel shelves, tray-shaped with rounded edges and high thickness, soundproofed and with satin finish - rubber shock absorber - multidirectional wheels  $\varnothing$  125 mm.

FR Structure tubulaire  $\varnothing$  25 mm en acier inox **AISI 304** - étagères en acier inox **AISI 304**, moulées en forme de plateau à bords arrondis et de grande épaisseur, insonorisées et satinées - butoirs en caoutchouc - roues multidirectionnelles  $\varnothing$  125 mm.

DE Rohrrahmen  $\varnothing$  25 mm aus Edelstahl **AISI 304** - Schallgedämmte Ablageflächen aus Edelstahl **AISI 304**, Tablett förmig bedruckt mit abgerundeten Kanten und satiniertes Oberfläche - Gummistoßschutz-Mehrwegräder  $\varnothing$  125 mm.

	CA 1415	CA 1416	CA 1417	CA 1424	CA 1425	CA 1426	CA 1427
							
 cm	100 x 70 x 104(h) cm	110 x 70 x 104(h) cm	128 x 70 x 104(h) cm	90 x 60 x 140(h) cm	110 x 60 x 140(h) cm	90 x 60 x 170(h) cm	110 x 60 x 170(h) cm
 N.	3			4		5	
 mm	90 x 60 cm	100 x 60 cm	120 x 60 cm	80 x 50 cm	100 x 50 cm	80 x 50 cm	100 x 50 cm
 MAX Kg	100 Kg			100 Kg		100 Kg	
	380 €	400 €	520 €	420 €	450 €	500 €	540 €

Carrelli di servizio in acciaio inox  
Stainless steel service trolleys

+5%

OPTIONAL



## CA 1390S - CA 1391S



CA 1390S

\* Sacchi non inclusi.  
Bags not included.  
Sacs non fournis.  
Säcke nicht enthalten.

h 52 cm

## CA 1391S2



\* Sacchi non inclusi.  
Bags not included.  
Sacs non fournis.  
Säcke nicht enthalten.

h 52 cm

+5%





IT Portarifiuti. Carrelli di servizio in acciaio inox. Struttura tubolare  $\varnothing$  25 mm in acciaio inox **AISI 304** - ripiani in acciaio inox **AISI 304** con fori per sacchi porta rifiuti - paracolpi in gomma - ruote multidirezionali  $\varnothing$  125 mm.

EN Garbage trolley. Stainless steel service trolleys. Tubular structure  $\varnothing$  25 mm in stainless steel **AISI 304** - stainless steel **AISI 304** shelves with holes for garbage bags - rubber stop - multidirectional wheels  $\varnothing$  125 mm.

FR Récipient à déchets. Chariots de service en acier inox Structure tubulaire  $\varnothing$  25 mm en acier inox **AISI 304** - étagères en acier inox **AISI 304** avec trous pour sacs à déchets - butoir en caoutchouc - roues multidirectionnelles  $\varnothing$  125 mm.

DE Abfallwagen. Servicewagen aus Edelstahl. Rohrrahmen  $\varnothing$  25 mm aus Edelstahl **AISI 304** - Ablageflächen aus Edelstahl **AISI 304** mit Löchern für Abfallsäcke - Gummistoßschutz- Mehrwegräder  $\varnothing$  125 mm.

	CA 1390S	CA 1391S
		
	90 x 60 x 94(h) cm	110 x 60 x 94(h) cm
	2	
	80 x 50 cm	100 x 50 cm
	100 Kg	
	300 €	320 €

	CA 1391S2
	
	110 x 60 x 94(h) cm
	2
	100 x 50 cm
	100 Kg
	370 €

## CA 1152 - CA 1154



CA 1152W

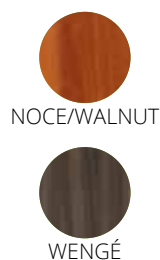

IT Carrelli di servizio con cupola. Struttura tubolare 20x20 mm in acciaio inox **AISI 304** - ripiani in nobilitato con cornice perimetrale in acciaio inox **AISI 304** - cupola in plexiglass semicircolare apribile su due lati - disponibile con ripiani colore noce o wengé - paracolpi in gomma - ruote multidirezionali  $\varnothing$  125 mm.

EN Service trolleys with dome. Tubular structure 20x20 mm in stainless steel **AISI 304** - melamine shelves with stainless steel **AISI 304** perimeter frame - half-circle dome in Plexiglas that opens on two sides - available with walnut or wenge colour shelves - rubber shock absorber - multidirectional wheels  $\varnothing$  125 mm.

FR Chariots de service avec clochette. Structure tubulaire 20x20 mm en acier inox **AISI 304** - étagères en mélaminé avec cadre périmétral en acier inox **AISI 304** - clochette en plexiglas semi-circulaire s'ouvrant sur deux côtés - disponible avec étagères en noyer ou wengé - butoir en caoutchouc - roues multidirectionnelles  $\varnothing$  125 mm.

DE Servicewagen für Kuchen. Rohrrahmen 20x20 mm aus Edelstahl **AISI 304** - Ablageflächen aus Melamin mit umlaufendem Rahmen aus Edelstahl **AISI 304** - zweiseitig aufklappbare, halbrunde Plexiglashaube - mit Ablageflächen in Nussbaum- oder Wengé-Farbe erhältlich - Gummistoßschutz - Mehrwegräder  $\varnothing$  125 mm.

i	CA 1152	CA 1152W	CA 1154	CA 1154W
cm	90 x 57 x 110(h) cm		111 x 57 x 110(h) cm	
N.	2			
MAX Kg	60 Kg			
	450 €		480 €	

+5%

## CA 1390C - CA 1391C



CA 1390C

IT Carrelli di servizio con cupola. Struttura tubolare  $\varnothing$  25 mm in acciaio inox **AISI 304** - ripiani in acciaio inox **AISI 304**, stampati, satinati e insonorizzati - cupola in plexiglass semicircolare apribile su due lati - paracolpi in gomma - ruote multidirezionali  $\varnothing$  125 mm.

EN Service trolleys with dome. Tubular structure  $\varnothing$  25 mm in stainless steel **AISI 304** - stainless steel **AISI 304** folded, satin-finished, soundproofed shelves - half-circle dome in Plexiglas that opens on two sides - rubber shock absorber - multidirectional wheels  $\varnothing$  125 mm.

FR Chariots de service avec clochette. Structure tubulaire  $\varnothing$  25 mm en acier inox **AISI 304** - étagères en acier inox **AISI 304** moulées, satinées, insonorisées - clochette en plexiglas semi-circulaire s'ouvrant sur deux côtés - butoir en caoutchouc - roues multidirectionnelles  $\varnothing$  125 mm.

DE Servicewagen für Kuchen. Rohrrahmen  $\varnothing$  25 mm aus Edelstahl **AISI 304** - vorgeformte schallgedämmte Ablageflächen aus Edelstahl **AISI 304** mit satinierter Oberfläche - zweiseitig aufklappbare, halbrunde Plexiglashaube - Gummistoßschutz - Mehrwegräder  $\varnothing$  125 mm.

i	CA 1390C	CA 1391C
cm	90 x 60 x 109(h) cm	110 x 60 x 109(h) cm
N.	2	
MAX Kg	100 Kg	
	440 €	460 €

Carrelli di servizio in acciaio inox con cupola  
Stainless steel service trolleys with dome

OPTIONAL



## CA 1162 - CA 1163



CA 1162

IT Carrelli di servizio con cupola. Struttura tubolare 20x20 mm in acciaio inox **AISI 304** - ripiani in acciaio inox **AISI 304**, stampati, satinati e insonorizzati - coperchio in plexiglass 150(h) mm - paracolpi in gomma - ruote multidirezionali ø 120 mm.

EN Service trolleys with dome. Tubular structure 20x20 mm in stainless steel **AISI 304** - stainless steel **AISI 304** folded, satin-finished, soundproofed shelves - Plexiglas lid 150(h) mm - rubber shock absorber - multidirectional wheels ø 120 mm.

FR Chariots de service avec clochette. Structure tubulaire 20x20 mm en acier inox **AISI 304** - étagères en acier inox **AISI 304** moulées, satinées, insonorisées - couvercle en plexiglas 150(h) mm - butoir en caoutchouc - roues multidirectionnelles ø 120 mm.

DE Servicewagen für Kuchen. Rohrrahmen 20x20 mm aus Edelstahl **AISI 304** - vorgeformte schallgedämmte Ablageflächen aus Edelstahl **AISI 304** mit satinierte Oberfläche - Deckel aus Plexiglas 150(h) mm - Gummistoßschutz- Mehrwegräder ø 125 mm.

i	CA 1162	CA 1163
↗ cm	118 x 57 x 104(h) cm	
N.	2	3
MAX Kg	80 Kg	
	560 €	640 €

+5%

## CA 1165



IT Carrello di servizio in acciaio inox con piastre eutettiche refrigeranti. Struttura tubolare in acciaio inox **AISI 304** 20x20 mm - 8 piastre eutettiche refrigerate incluse - coperchio in plexiglass 150(h) mm - vasca e griglia in acciaio inox - predisposto per una capacità di n. 5 bacinelle GN1/4 e n. 5 bacinelle GN1/6 65(h) mm. Bacinelle non incluse nel prezzo.

EN Stainless steel service trolley with refrigerated electric plates. Tubular structure 20x20 mm in stainless steel **AISI 304** - 8 refrigerated eutectic plates included - Plexiglas lid 150(h) mm - stainless steel bowl and grid - equipped for up to 5 GN1/4 containers and 5 GN1/6 65(h) mm containers. Containers not included in the price.

FR Chariot de service en acier inox avec plaques de refroidissement électriques. Structure tubulaire en acier inox **AISI 304** 20x20 mm - 8 plaques eutectiques réfrigérées incluses - couvercle en plexiglas 150(h) mm - cuve et grille en acier inox - équipés pour une capacité de 5 bacs GN1/4 et 5 bacs GN1/6 65(h) mm. Bacs non compris dans le prix.

DE Edelstahl-Servicewagen mit elektrischen Kühlplatten. Rohrrahmen aus Edelstahl **AISI 304** 20x20 mm - 8 eutektische Kühlplatten im Lieferumfang enthalten - Plexiglasdeckel 150(h) mm - Edelstahlwanne und Gitter - enthält 5 GN1/4 Behälter mit 65(h) mm oder 5 GN1/6 Behälter mit 65(h) mm. Behälter nicht im Preis begriffen.

i	CA 1165
↗ cm	108 x 57 x 104(h) cm
N.	2
MAX Kg	80 Kg
	800 €

## CA 1388





IT Carrelli di servizio in acciaio inox per sbarazzo. Struttura tubolare in acciaio inox **AISI 304**, 20x20 mm - vasca in acciaio inox **AISI 304** - piano inferiore inox piegato - ruote multidirezionali ø 125 mm.

EN Stainless steel service trolleys for disposal. Tubular structure in stainless steel **AISI 304**, 20x20 mm - stainless steel **AISI 304** bowl - lower folded stainless steel shelf - multidirectional wheels ø 125 mm.

FR Chariots de service en acier inox pour le rangement. Structure tubulaire en acier inox **AISI 304**, 20x20 mm - cuve en acier inox **AISI 304** - plateau inférieur courbé en acier inox - roues multidirectionnelles ø 125 mm.

DE Servicewagen aus Edelstahl zum Abräumen. Rohrrahmen aus Edelstahl **AISI 304**, 20x20 mm - Wanne aus Edelstahl **AISI 304** - Bodenfläche aus gebogenem Edelstahl - Mehrwegräder ø 125 mm.

	CA 1388
	101 x 57 x 97(h) cm
	2
	90 x 50 cm
	1 x 150(h) mm
	80 Kg
	<b>385 €</b>

**+5%**

## CA 1389









IT Carrelli di servizio in acciaio inox per sbarazzo. Struttura tubolare in acciaio inox **AISI 304**, 20x20 mm - vasche in acciaio inox **AISI 304** insonorizzate 150(h) mm - ruote multidirezionali ø 125 mm.

EN Stainless steel service trolleys for disposal. Tubular structure in stainless steel **AISI 304**, 20x20 mm - stainless steel **AISI 304** soundproofed bowls 150(h) mm - multidirectional wheels ø 125 mm.

FR Chariots de service en acier inox pour le rangement. Structure tubulaire en acier inox **AISI 304**, 20x20 mm - cuve en acier inox **AISI 304** insonorisées 150(h) mm - plateau inférieur courbé en acier inox - roues multidirectionnelles ø 125 mm.

DE Servicewagen aus Edelstahl zum Abräumen. Rohrrahmen aus Edelstahl **AISI 304**, 20x20 mm - schallgedämmte Wanne aus Edelstahl **AISI 304** 150(h) mm - Mehrwegräder ø 125 mm.

	CA 1389
	101 x 57 x 97(h) cm
	2
	90 x 50 cm
	2 x 150(h) mm
	80 Kg
	<b>440 €</b>

Carrelli di servizio in acciaio inox per sbarazzo  
Stainless steel service trolleys for disposal

OPTIONAL



## CA 1396



IT Carrelli di servizio in acciaio inox per sbarazzo. Struttura tubolare in acciaio inox **AISI 304**, 20x20 mm - vasche insonorizzate in acciaio inox **AISI 304**, 65(h) mm - ruote multidirezionali  $\varnothing$  125 mm.

EN Stainless steel service trolleys for disposal. Tubular structure in stainless steel **AISI 304**, 20x20 mm - stainless steel **AISI 304** soundproofed bowls, 65(h) mm - multidirectional wheels  $\varnothing$  125 mm.

FR Chariots de service en acier inox pour le rangement. Structure tubulaire en acier inox **AISI 304**, 20x20 mm - cuve en acier inox **AISI 304** insonorisées 65(h) mm - roues multidirectionnelles  $\varnothing$  125 mm.

DE Servicewagen aus Edelstahl zum Abräumen. Rohrrahmen aus Edelstahl **AISI 304**, 20x20 mm - schallgedämmte Wanne aus Edelstahl **AISI 304** 65(h) mm - Mehrwegräder  $\varnothing$  125 mm.

	CA 1396
	91 x 57 x 97(h) cm
	2
	90 x 50 cm
	2 x 65(h) mm
	80 Kg
	340 €

+5%

## CA 1386 - CA 1387



CA 1386

IT Carrello portabacinelle con struttura tubolare tonda  $\varnothing$  25 mm in acciaio inox **AISI 304** - livello superiore adatto a contenere fino a 3 bacinelle GN1/1 o 2 bacinelle GN1/1 - piano inferiore in acciaio inox **AISI 304**, piegato e insonorizzato - paracolpi in gomma - ruote multidirezionali  $\varnothing$  125 mm. Bacinelle escluse.

EN Containers trolley with round tubular frame  $\varnothing$  25 mm in stainless steel **AISI 304** - upper level designed to accommodate up to 3 GN1/1 or 2 GN1/1 containers - lower level in stainless steel **AISI 304**, folded and soundproofed - rubber shock absorber - multidirectional wheels  $\varnothing$  125 mm. Containers not included.

FR Chariot porte-bacs avec structure tubulaire ronde  $\varnothing$  25 mm en acier inox **AISI 304** - niveau supérieur pour 3 bacs GN1/1 ou 2 bacs GN1/1 - niveau inférieur en acier inox **AISI 304**, plié et insonorisé - butoir en caoutchouc - roues multidirectionnel  $\varnothing$  125 mm. Bacs non compris

DE Behälterhalterwagen mit Rohrrahmen  $\varnothing$  25 mm aus Edelstahl **AISI 304** - obere Ebene zur Aufnahme von bis zu 3 GN1/1 oder 2 GN1/1 Behälter - vorgeformte, schallgedämmte Bodenfläche aus Edelstahl - Gummistoßschutz - Mehrwegräder  $\varnothing$  125 mm. Behälter nicht enthalten

	CA 1386	CA 1387
	77 x 62 x 97(h) cm	110 x 62 x 97(h) cm
	2	
	100 Kg	
	250 €	270 €

## CA 1430



## CA 1431



## CA 1432





IT Carrelli di servizio inox per trasporto pesante. Struttura tubolare tonda  $\varnothing$  25 mm, in acciaio inox **AISI 304** - ripiani in acciaio inox **AISI 304**, stampati in forma di vassoio con bordi arrotondati e alto spessore, insonorizzati e con finitura satinata - paracolpi in gomma - ruote multidirezionali  $\varnothing$  125 mm.

EN Stainless steel service trolleys for heavy transport. Tubular structure  $\varnothing$  25 mm in stainless steel **AISI 304** - **AISI 304** stainless steel shelves, tray-shaped with rounded edges and high thickness, soundproofed and with satin finish - rubber shock absorber - multidirectional wheels  $\varnothing$  125 mm.

FR Chariots de service inox pour le transport de poids. Structure tubulaire ronde  $\varnothing$  25 mm en acier inox **AISI 304** - étagères en acier inox **AISI 304**, moulées en forme de plateau à bords arrondis et de grande épaisseur, insonorisées et satinées - butoirs en caoutchouc - roues multidirectionnelles  $\varnothing$  125 mm.

DE Servicewagen aus Edelstahl für Schwerlasten. Runder Rohrrahmen  $\varnothing$  25 mm, aus Edelstahl **AISI 304** - Schallgedämmte Ablageflächen aus Edelstahl **AISI 304**, Tablett förmig bedruckt mit abgerundeten Kanten und satinierter Oberfläche - Gummistoßschutz- Mehrwegräder  $\varnothing$  125 mm.

	CA 1430	CA 1431	CA 1432	CA 1433
	110 x 60 x 100(h) cm		110 x 60 x 130(h) cm	110 x 60 x 160(h) cm
	2	3	4	5
	100 x 50 cm			
	150 Kg			
	380 €	450 €	550 €	640 €

A richiesta spediti anche smontati.  
On request also shipped disassembled.

**+5%**

## CA 1433



Carrelli di servizio in acciaio inox per trasporto pesante  
Stainless steel service trolleys for heavy transport

OPTIONAL



## CA 1392P - CA 1393P



CA 1393P



A 514

OPTIONAL



IT Carrelli di servizio inox per trasporto pesante. Struttura tubolare in acciaio inox **AISI 304** 25x25 mm - ripiani in acciaio inox **AISI 304**, piegati con omega di rinforzo, satinati e insonorizzati - paracolpi in gomma - ruote multidirezionali  $\varnothing$  125 mm.

EN Stainless steel service trolleys for heavy transport. Tubular structure 25x25 mm in stainless steel **AISI 304** - **AISI 304** stainless steel, folded shelves with support omega, satin-finished and soundproofed - rubber shock absorber - multidirectional wheels  $\varnothing$  125 mm.

FR Chariots de service inox pour le transport de poids. Structure tubulaire 25x25 mm en acier inox **AISI 304** - étagères en acier inox **AISI 304** pliées avec renforcement oméga, satinées et insonorisées - butoirs en caoutchouc - roues multidirectionnelles  $\varnothing$  125 mm.

DE Servicewagen aus Edelstahl für Schwerlasten. Rohrrahmen 25x25 mm aus Edelstahl **AISI 304** - mit Omega Verstärkung gebogene, schallgedämmte Ablageflächen aus Edelstahl **AISI 304** mit satiniertes Oberfläche - Gummistoßschutz - Mehrwegräder  $\varnothing$  125 mm.

	CA 1392P	CA 1393P
	92 x 67 x 98(h) cm	112 x 67 x 98(h) cm
	2	
	80 x 60 cm	100 x 60 cm
	200 Kg	
	390 €	420 €

## CA 1394P - CA 1395P



CA 1395P

+5%

	CA 1394P	CA 1395P
	92 x 67 x 98(h) cm	112 x 67 x 98(h) cm
	3	
	80 x 60 cm	100 x 60 cm
	200 Kg	
	530 €	580 €



## CP 1008







IT Carrelli di servizio multiuso in plastica con montanti in alluminio anodizzato.

EN Multipurpose plastic service trolleys with anodised aluminium uprights.

FR Chariots polyvalente en plastique avec montants en aluminium anodisé.

DE Mehrzweck-Servicewagen aus Kunststoff mit Trägern aus eloxiertem Aluminium.

	CP 1008
	85 x 43 x 95(h) cm
	3
	40 Kg
	90 €

Carrelli di servizio multiuso in plastica  
Multipurpose plastic service trolleys

+5%

## CP 1010



A 1001	A 1002
Cestino piccolo / Small basket Petit panier / Klein Korb	Cestino grande / Big basket Grand panier / Gros Korb
10 €	25 €

IT Carrelli di servizio multiuso in plastica con montanti in alluminio anodizzato.

EN Multipurpose plastic service trolleys with anodised aluminium uprights.

FR Chariots polyvalente en plastique avec montants en aluminium anodisé.

DE Mehrzweck-Servicewagen aus Kunststoff mit Trägern aus eloxiertem Aluminium.

	CP 1010
	102 x 50 x 96(h) cm
	3
	40 Kg
	135 €



Il carrello in foto è con optional A1001 e A1002  
The trolley shown is equipped with A1001 and A1002  
Le chariot illustré est équipé avec A1001 et A1002  
Der abgebildete Wagen ist mit A1001 und A1002ausgestattet



# Carrelli ed Espositori refrigerati e termici in legno

WOODEN REFRIGERATED  
AND HEATED TROLLEYS AND DISPLAYS  
CHARIOTS ET PRÉSENTOIRS  
EN BOIS RÉFRIGÉRÉS ET THERMIQUES  
KÜHL- UND HEIZWAGEN  
UND -DISPLAYS AUS HOLZ

# CLR 2788NW



IT Carrelli refrigerati in legno con cupola in plexiglass. Struttura in legno multistrato di betulla - cupola semicircolare in plexiglass - refrigerazione statica - modelli con 2 mensole ripieghevoli - colore noce o wengé - ruote multidirezionali Ø 100 mm. Bacinelle escluse - le temperature di lavoro indicate sono da considerarsi con coperchi posizionati.

EN Wooden refrigerated trolleys with Plexiglas dome. Multi-layered birch wood structure - half-round Plexiglas dome - static refrigeration - two foldable shelves models - walnut or wenge colour - multidirectional wheels Ø 100 mm. Basins excluded - the indicated working temperatures are to be considered with positioned lids.

FR Chariots réfrigérés en bois avec clochette en plexiglas. Structure en multicouche de bouleau - clochette en plexiglas semi-circulaire - réfrigération statique - modèles avec 2 étagères escamotables - couleur noyer ou wengé - roues multidirectionnelles Ø 100 mm. Bacs non compris - les températures de travail indiquées sont à considérer avec couvercles en place.

DE Kühlwagen aus Holz mit Plexiglashaube. Birkensterrholzstruktur - halbrunde Plexiglashaube - statische Kühlung - Modelle mit 2 Faltflächen - erhältlich in Walnuss oder Wenge - Mehrwegräder Ø 100 mm. Behälter nicht enthalten - die angegebenen Arbeitstemperaturen sind bei aufgesetzten Deckeln zu verstehen.

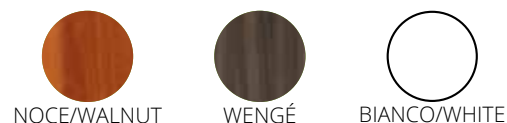

	CLR 2788N noce-walnut	CLR 2788NW wengé	CLR 2788NB bianco-white	CLR 2788NBT noce-walnut	CLR 2788NBTW wengé	CLR 2788NBTB bianco-white
	230V - 50Hz					
	+2°C +10°C			-5°C +5°C		
	R600a					
	3 x GN1/1 - 150(h) mm					
	2800 €	3000 €		3100 €		3300 €

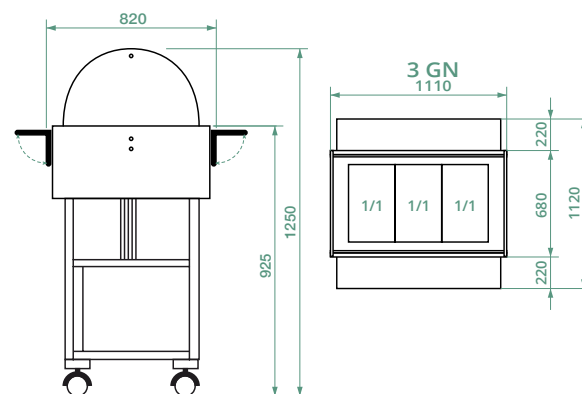

Carrelli refrigerati in legno  
Wooden refrigerated trolleys

+5%

OPTIONAL



# CLR 2787N



IT Carrelli refrigerati in legno con cupola in plexiglass. Struttura in legno multistrato di betulla - cupola semicircolare in plexiglass - refrigerazione statica - modelli disponibili con 1 mensola ripieghevole e 1 piano di appoggio - colore noce o wengé - ruote multidirezionali ø 100 mm. Bacinelle escluse - le temperature di lavoro indicate sono da considerarsi con coperchi posizionati.

EN Wooden refrigerated trolleys with Plexiglas dome. Multi-layered birch wood structure - half-round Plexiglas dome - static refrigeration - models with foldable shelf and support base - walnut or wenge colour - multidirectional wheels ø 100 mm. Containers not included - the operating temperatures listed are to be considered with lids on.

FR Chariots réfrigérés en bois avec clochette en plexiglas. Structure en multicouche de bouleau - clochette en plexiglas semi-circulaire - réfrigération statique - modèles avec 1 étagère et plan de travail - couleur noyer ou wengé - roues multidirectionnelles ø 100 mm. Bacs no compris - les températures de travail indiquées sont à considérer avec couvercles en place.

DE Kühlwagen aus Holz mit Plexiglashaube. Birkensperrholzstruktur - halbrunde Plexiglashaube - statische Kühlung - Modelle mit 1 Faltfläche und 1 Ablagefläche - erhältlich in Walnuss oder Wenge - Mehrwegräder ø 100 mm. Behälter nicht enthalten - die angegebenen Arbeitstemperaturen sind bei aufgesetzten Deckeln zu verstehen.



NOCE/WALNUT



WENGÉ



BIANCO/WHITE

	CLR 2787N noce-walnut	CLR 2787NW wengé	CLR 2787NB bianco-white	CLR 2787NBT noce-walnut	CLR 2787NBTW wengé	CLR 2787NBTB bianco-white
						
	230V - 50Hz					
	+2°C +10°C			-5°C +5°C		
	R600a					
	3 x GN1/1 - 150(h) mm					
	2800 €	3000 €		3100 €		3300 €

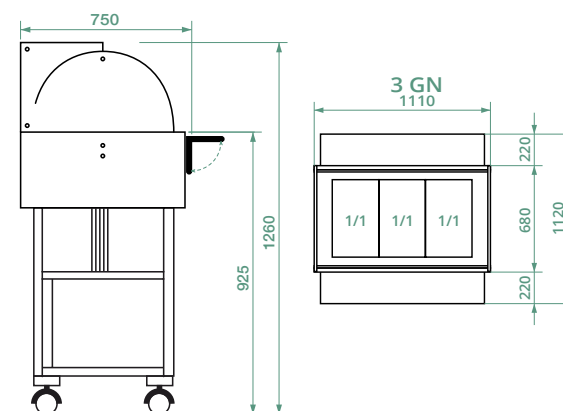

# CLR 2786NB

**NEW**







IT Carrelli refrigerati in legno con luce al neon. Struttura in legno multistrato di betulla - cupola in plexiglass - refrigerazione statica - 2 mensole ripieghevoli - disponibili nei colori noce o wengé - 1 luce al neon - ruote multidirezionali Ø 100 mm. Bacinelle escluse - le temperature di lavoro indicate sono da considerarsi con coperchi posizionati.

EN Refrigerated wooden trolleys with neon light. Multi-layered birch wood structure - half-round Plexiglas dome - static refrigeration - 2 foldable shelves - available in walnut or wenge colour - 1 neon light - multidirectional wheels Ø 100 mm. Containers not included - the operating temperatures listed are to be considered with lids on.

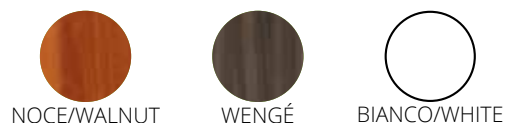
FR Chariots réfrigérés en bois avec lampe néon. Structure en multicouche de bouleau - clochette en plexiglas - réfrigération statique - 2 étagères escamotables - couleur noyer ou wengé - 1 lampe néon - roues multidirectionnelles Ø 100 mm. Bacs non compris - les températures de travail indiquées sont à considérer avec couvercles en place.

DE Kühlwagen aus Holz mit Neonlampe. Birkensperrholzstruktur - Plexiglashaube - statische Kühlung - 2 Faltflächen- erhältlich in Walnuss oder Wenge - 1 Neonlampe - Mehrwegräder Ø 100 mm. Behälter nicht enthalten - die angegebenen Arbeitstemperaturen sind bei aufgesetzten Deckeln zu verstehen.



	CLR 2786N noce-walnut	CLR 2786NW wengé	CLR 2786NB bianco-white	CLR 2786NBT noce-walnut	CLR 2786NBTW wengé	CLR 2786NBTB bianco-white
						
	230V - 50Hz					
	+2°C +10°C			-5°C +5°C		
	R600a					
	3 x GN1/1 - 150(h) mm					
	2900 €	3100 €	3100 €	3200 €	3200 €	3400 €

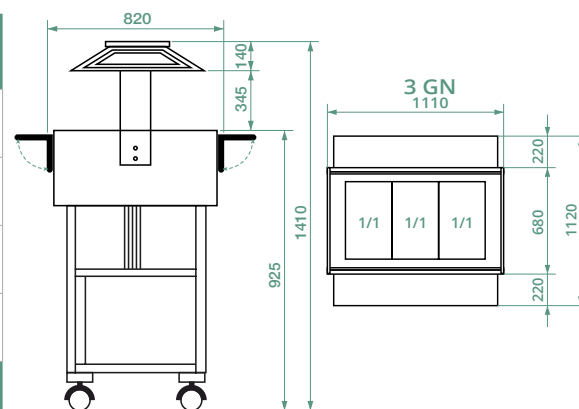

Carrelli refrigerati in legno  
Wooden refrigerated trolleys

**+5%**

OPTIONAL



## ELR 2827



## ELR 2827BTW



NOCE/WALNUT



WENGÉ



BIANCO/WHITE

IT Espositori refrigerati in legno con cupola. Struttura in legno multistrato di betulla - cupola semicircolare in plexiglass - refrigerazione statica - disponibili con 2 mensole ripieghevoli - colore noce o wengé - ruote multidirezionali ø 75 mm. Bacinelle escluse - le temperature di lavoro indicate sono da considerarsi con coperchi posizionati.

FR Présentoirs réfrigérés en bois avec clochette. Structure en multicouche de bouleau - clochette en plexiglas semi-circulaire - réfrigération statique - modèles avec 2 étagères escamotables - couleur noyer ou wengé - roues multidirectionnelles ø 75 mm. Bacs non compris - les températures de travail indiquées sont à considérer avec couvercles en place.

EN Refrigerated wooden displays with dome. Multi-layered birch wood structure - half-round Plexiglas dome - static refrigeration - two foldable shelves models - walnut or wenge colour - multidirectional wheels ø 75 mm. Containers not included - the operating temperatures listed are to be considered with lids on.

DE Kühlvitrinen aus Holz mit Haube. Birkensperrholzstruktur - halbrunde Plexiglashaube - statische Kühlung - mit 2 Faltflächen- erhältlich in Walnuss oder Wenge - Mehrwegräder ø 75 mm. Behälter nicht enthalten - die angegebenen Arbeitstemperaturen sind bei aufgesetzten Deckeln zu verstehen.

	ELR 2827 noce-walnut	ELR 2827W wengé	ELR 2827B bianco-white	ELR 2827BT noce-walnut	ELR 2827BTW wengé	ELR 2827BTB bianco-white
						
	230V - 50Hz					
	+2°C +10°C			-5°C +5°C		
	R600a					
	4 x GN1/1 - 150(h) mm					
	2900 €	3100 €	3100 €	3300 €	3300 €	3500 €

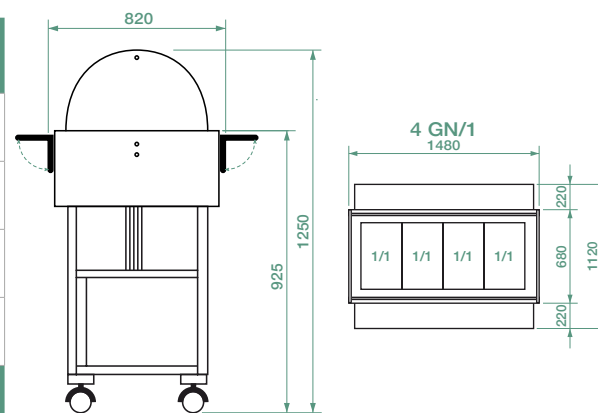

# ELR 2826



# ELR 2826BTW

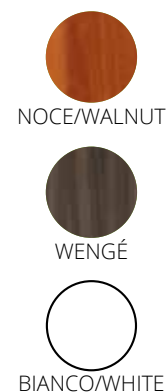

IT Espositori refrigerati in legno con cupola. Struttura in legno multistrato di betulla - cupola semicircolare in plexiglass - refrigerazione statica - disponibili con 1 mensola ripieghevole e 1 piano di appoggio - colore noce o wengé - ruote multidirezionali ø 75 mm. Bacinelle escluse - le temperature di lavoro indicate sono da considerarsi con coperchi posizionati.

FR Présentoirs réfrigérés en bois avec clochette. Structure en multicouche de bouleau - clochette en plexiglas semi-circulaire - réfrigération statique - avec 1 étagère escamotable et plan de travail - couleur noyer ou wengé - roues multidirectionnelles ø 75 mm. Bacs non compris - les températures de travail indiquées sont à considérer avec couvercles en place.

EN Refrigerated wooden displays with dome. Multi-layered birch wood structure - half-round Plexiglas dome - static refrigeration - models with 1 foldable shelf and 1 support base - walnut or wenge colour - multidirectional wheels ø 75 mm. Containers not included - the operating temperatures listed are to be considered with lids on.

DE Kühlvitrinen aus Holz mit Haube. Birkensperrholzstruktur - halbrunde Plexiglashaube - statische Kühlung - Modelle mit 1 faltfläche und 1 Ablagefläche - erhältlich in Walnuss oder Wenge - Mehrwegräder ø 75 mm. Behälter nicht enthalten - die angegebenen Arbeitstemperaturen sind bei aufgesetzten Deckeln zu verstehen.

	ELR 2826 noce-walnut	ELR 2826W wengé	ELR 2826B bianco-white	ELR 2826BT noce-walnut	ELR 2826BTW wengé	ELR 2826BTB bianco-white
						
	230V - 50Hz					
	+2°C +10°C			-5°C +5°C		
	R600a					
	4 x GN1/1 - 150(h) mm					
	2900 €		3100 €		3300 €	3500 €

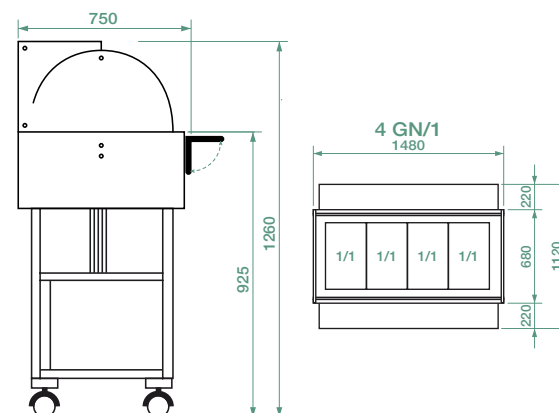

Espositori refrigerati in legno  
Wooden refrigerated displays

**+5%**

OPTIONAL



## ELR 2825



## ELR 2825BTW

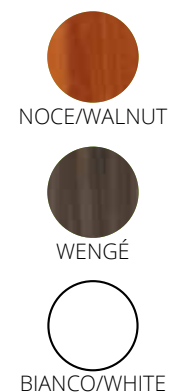

IT Espositori refrigerati in legno con luce al neon. Struttura in legno multistrato di betulla - cupola in plexiglass - refrigerazione statica - 2 mensole ripieghevoli - disponibile nei colori noce o wengé - 1 luce al neon - ruote multidirezionali ø 75 mm. Bacinelle escluse - le temperature di lavoro indicate sono da considerarsi con coperchi posizionati.

FR Présentoirs réfrigérés en bois avec lampe néon. Structure en multicouche de bouleau - clochette en plexiglas - réfrigération statique - 2 étagères escamotables - disponible en couleur noyer ou wengé - 1 lampe néon - roues multidirectionnelles ø 75 mm. Bacs non compris - les températures de travail indiquées sont à considérer avec couvercles en place.

EN Refrigerated wooden displays with neon light. Multi-layered birch wood structure - Plexiglas dome - static refrigeration - 2 foldable shelves - available in walnut or wenge colour - 1 neon light - multidirectional wheels ø 75 mm. Containers not included - the operating temperatures listed are to be considered with lids on.

DE Kühlvitrinen aus Holz mit Neonlampe. Birkensperrholzstruktur - Plexiglashaube - statische Kühlung - 2 faltflächen- erhältlich in Walnuss oder Wenge - 1 Neonlampe - Mehrwegräder ø 75 mm. Behälter nicht enthalten - die angegebenen Arbeitstemperaturen sind bei aufgesetzten Deckeln zu verstehen.

	ELR 2825 noce-walnut	ELR 2825W wengé	ELR 2825B bianco-white	ELR 2825BT noce-walnut	ELR 2825BTW wengé	ELR 2825BTB bianco-white
						
	230V - 50Hz					
	+2°C +10°C			-5°C +5°C		
	R600a					
	4 x GN1/1 - 150(h) mm					
	3050 €		3250 €		3450 €	3650 €

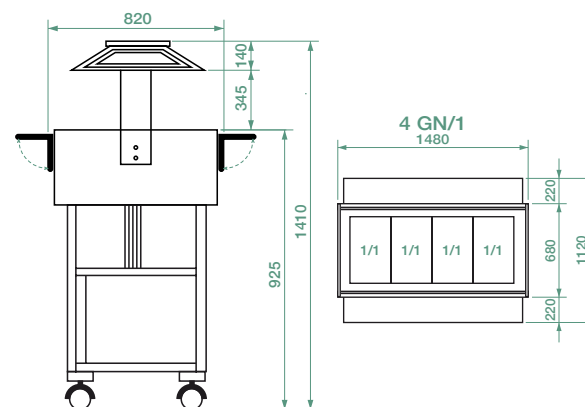



# CL 2777NW



IT Carrelli termico a bagnomaria in legno, con cupola. Struttura in legno multistrato di betulla - cupola semicircolare in plexiglass - riscaldato con resistenza elettrica- disponibili con 2 mensole ripieghevoli - colore noce o wengé - ruote multidirezionali ø 100 mm. Bacinelle escluse - le temperature di lavoro indicate sono da considerarsi con coperchi posizionati.

EN Wooden heated bain-marie trolleys with dome. Multi-layered birch wood structure - half-round Plexiglas dome - electric heating element - available with two foldable shelves - walnut or wenge colour - multidirectional wheels ø 100 mm. Containers not included - the operating temperatures listed are to be considered with lids on.

FR Wooden heated bain-marie trolleys with dome. Multi-layered birch wood structure - half-round Plexiglas dome - electric heating element - available with two foldable shelves - walnut or wenge colour - multidirectional wheels ø 100 mm. Containers not included - the operating temperatures listed are to be considered with lids on.

DE Bain-Marie Heizwagen aus Holz mit Haube. Birkensperrholzstruktur - halbrunde Plexiglashaube - mit elektrischem Heizstab beheizt - mit 2 faltflächen- erhältlich in Walnuss oder Wenge - Mehrwegräder ø 100 mm. Behälter nicht enthalten - die angegebenen Arbeitstemperaturen sind bei aufgesetzten Deckeln zu verstehen.



NOCE/WALNUT



WENGÉ



BIANCO/WHITE

	CL 2777N noce-walnut	CL 2777NW wengé	CL 2777NB bianco-white
	2000 W		
	230V - 50Hz		
	+30°C +90°C		
	3 x GN1/1 - 150(h) mm		
	1930 €		2130 €

**+5%**

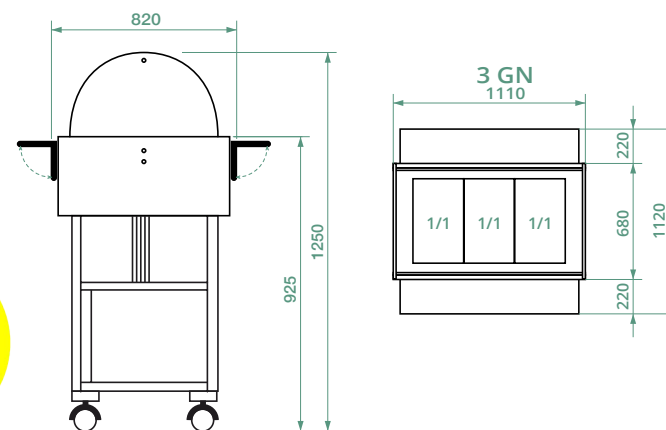

Carrelli termici a bagnomaria in legno  
Wooden bain-marie trolleys

OPTIONAL



65



57

# CL 2778N



IT Carrelli termico a bagnomaria in legno, con cupola. Struttura in legno multistrato di betulla - cupola semicircolare in plexiglass - riscaldato con resistenza elettrica - disponibili con 1 mensola ripieghevole e 1 piano di appoggio - colore noce o wengé - ruote multidirezionali ø 100 mm. Bacinelle escluse - le temperature di lavoro indicate sono da considerarsi con coperchi posizionati.

EN Wooden heated bain-marie trolleys with dome. Multi-layered birch wood structure - half-round Plexiglas dome - electric heating element - available with 1 foldable shelf and 1 support base - walnut or wenge colour - multidirectional wheels ø 100 mm. Containers not included - the operating temperatures listed are to be considered with lids on.

FR Chariots bain-marie chauffants en bois avec clochette. Structure en multicouche de bouleau - clochette en plexiglas semi-circulaire - chauffé par résistance électrique - disponibles avec 1 étagère escamotable et 1 plan de travail - couleur noyer ou wengé - roues multidirectionnelles ø 100 mm. Bacs non compris - les températures de travail indiquées sont à considérer avec couvercles en place.

DE Bain-Marie Heizwagen aus Holz mit Haube. Birkensperrholzstruktur - halbrunde Plexiglashaube - mit elektrischem Heizstab beheizt - mit 1 Falfläche und 1 Ablagefläche - erhältlich in Walnuss oder Wenge - Mehrwegräder ø 100 mm. Behälter nicht enthalten - die angegebenen Arbeitstemperaturen sind bei aufgesetzten Deckeln zu verstehen.

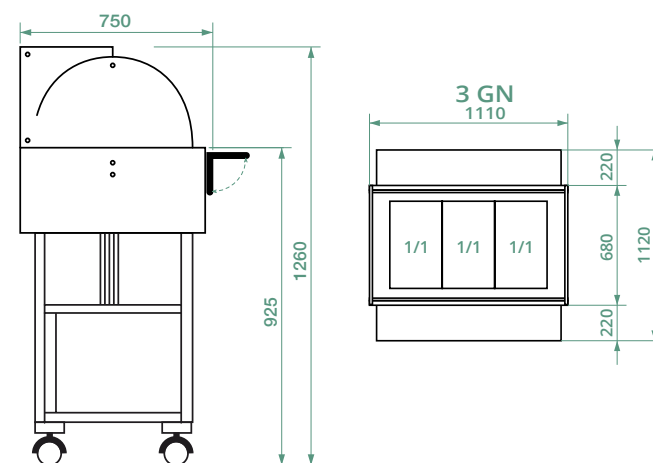
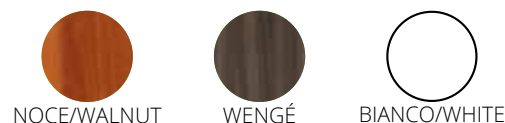

	CL 2778N noce-walnut	CL 2778NW wengé	CL 2778NB bianco-white
	2000 W		
	230V - 50Hz		
	+30°C +90°C		
	3 x GN1/1 - 150(h) mm		
	1930 €		2130 €

**+5%**

# CL 2774NW



IT Carrello termico a bagnomaria in legno, da buffet. Struttura in legno multistrato di betulla - cupola in plexiglass - luce al neon - riscaldato con resistenza elettrica - disponibili con 2 mensole ripieghevoli colore noce o wengé - ruote multidirezionali ø 100 mm. Bacinelle escluse - le temperature di lavoro indicate sono da considerarsi con coperchi posizionati.

EN Wooden heated bain-marie trolley, for buffet. Multi-layered birch wood structure - half-round Plexiglas dome - neon light - electric heating element - available with two foldable shelves - walnut or wenge colour - multidirectional wheels ø 100 mm. Containers not included - the operating temperatures listed are to be considered with lids on.

FR Chariots bain-marie chauffants en bois, pour buffet. Structure en multicouche de bouleau - clochette en plexiglas - lampe néon - chauffé par résistance électrique - disponibles avec 2 étagères escamotables - couleur noyer ou wengé - roues multidirectionnelles ø 100 mm. Bacs non compris - les températures de travail indiquées sont à considérer avec couvercles en place.

DE Bain-Marie Heizwagen aus Holz für Buffets. Birkensperrholzstruktur - Plexiglashaube - Neonlampe - mit elektrischem Heizstab beheizt - mit 2 faltflächen - erhältlich in Walnuss oder Wenge - Mehrwegräder ø 100 mm. Behälter nicht enthalten - die angegebenen Arbeitstemperaturen sind bei aufgesetzten Deckeln zu verstehen.



NOCE/WALNUT



WENGÉ



BIANCO/WHITE

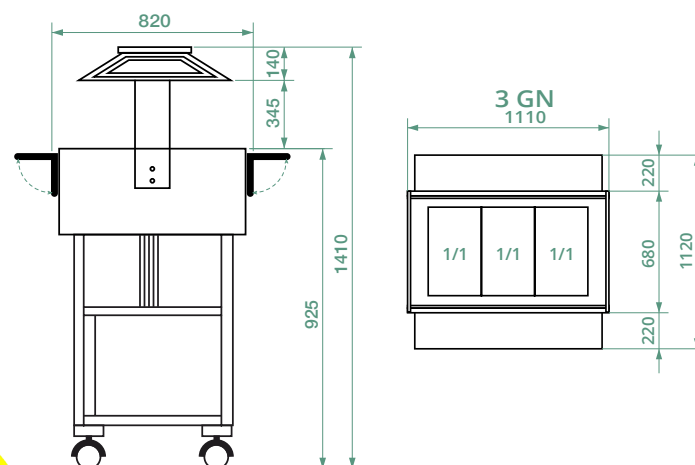

i	CL 2774N noce-walnut	CL 2774NW wengé	CL 2774NB bianco-white
⚡		2000 W	
1 Ph		230V - 50Hz	
🌡️		+30°C +90°C	
N.		3 x GN1/1 - 150(h) mm	
	2000 €		2200 €

+5%

Carrelli termici a bagnomaria in legno  
Wooden heated bain-marie trolleys

OPTIONAL



65

59

# CL 2772N



NOCE/WALNUT



IT Carrello termico a bagnomaria in legno. Struttura in legno multistrato di betulla - 1 mensola ripieghevole - disponibile in colore noce - ruote multidirezionali ø 100 mm. Bacinelle escluse - le temperature di lavoro indicate sono da considerarsi con coperchi posizionati.

EN Wooden heated bain-marie trolley Multi-layered birch wood structure - 1 folding shelf - available in walnut colour - multidirectional wheels ø 100 mm. Containers not included - the operating temperatures listed are to be considered with lids on.

FR Chariots bain-marie chauffants en bois. Structure en bois massif - 1 étagère escamotable - disponible en couleur noyer - roues multidirectionnelles de ø 100 mm. Bacs non compris - les températures de travail indiquées sont à considérer avec couvercles en place.

DE Bain-Marie Heizwagen aus Holz. Birkensperrholzstruktur - 1 Faltfläche - erhältlich in Walnussfarbe - Mehrwegräder ø 100 mm. Behälter nicht enthalten - die angegebenen Arbeitstemperaturen sind bei aufgesetzten Deckeln zu verstehen.

	CL 2772N noce-walnut
	2000 W
	230V - 50Hz
	+30°C +90°C
	<b>3 x GN1/1 - 150(h) mm</b>
	123 x 70 x 135(h) cm
	<b>1800 €</b>

+5%



Carrelli termici a bagnomaria in legno  
Wooden heated bain-marie trolley

forcar®

## ELC 2832



## ELC 2832W

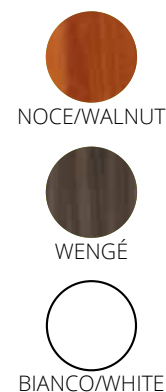

IT Espositore termico a bagnomaria in legno, con cupola. Struttura in legno multistrato di betulla - cupola semicircolare in plexiglass - riscaldato con resistenza elettrica- disponibili con 2 mensole ripieghevoli - colore noce o wengé - ruote multidirezionali  $\varnothing$  75 mm. Bacinelle escluse - le temperature di lavoro indicate sono da considerarsi con coperchi posizionati.

FR Présentoir bain-marie chauffants en bois avec clochette. Structure en multicouche de bouleau - clochette en plexiglas semi-circulaire - chauffé par résistance électrique - disponibles avec 2 étagères escamotables - couleur noyer ou wengé - roues multidirectionnelles  $\varnothing$  75 mm. Bacs non compris - les températures de travail indiquées sont à considérer avec couvercles en place.

EN Wooden heated bain-marie display with dome. Multi-layered birch wood structure - half-round Plexiglas dome - electric heating element - available with two foldable shelves - walnut or wenge colour - multidirectional wheels  $\varnothing$  75 mm. Containers not included - the operating temperatures listed are to be considered with lids on.

DE Bain-Marie Heizvitrine aus Holz mit Haube. Birkensperrholzstruktur - halbrunde Plexiglashaube - mit elektrischem Heizstab beheizt - mit 2 Falträumen - erhältlich in Walnuss oder Wenge - Mehrwegräder  $\varnothing$  75 mm. Behälter nicht enthalten - die angegebenen Arbeitstemperaturen sind bei aufgesetzten Deckeln zu verstehen.

	ELC 2832 noce-walnut	ELC 2832W wengé	ELC 2832B bianco-white
		2000 W	
		230V - 50Hz	
		+30°C +90°C	
		4 x GN1/1 - 150(h) mm	
	2030 €		2230 €

+5%

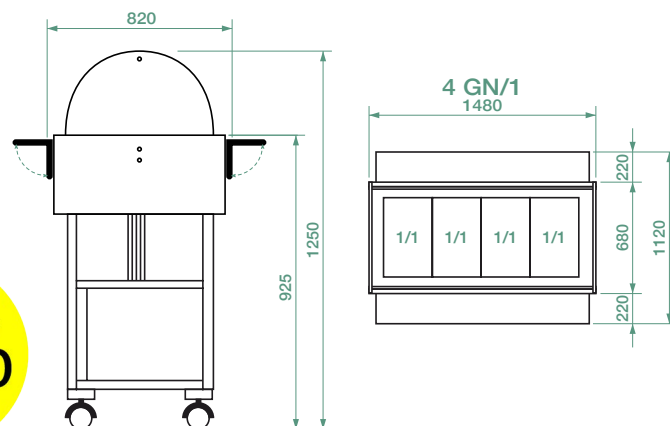

Espositori termici a bagnomaria in legno  
Wooden heated bain-marie displays

OPTIONAL



## ELC 2834B

**NEW**



## ELC 2834

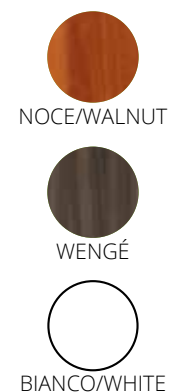

IT Espositore termico a bagnomaria in legno, con cupola. Struttura in legno multistrato di betulla - cupola semicircolare in plexiglass - riscaldato con resistenza elettrica - disponibili con 1 mensola ripieghevole e 1 piano di appoggio - colore noce o wengé - ruote multidirezionali  $\varnothing$  75 mm. Bacinelle escluse - le temperature di lavoro indicate sono da considerarsi con coperchi posizionati.

FR Présentoir bain-marie chauffants en bois avec clochette. Structure en multicouche de bouleau - clochette en plexiglas semi-circulaire - chauffé par résistance électrique - disponibles avec 1 étagère escamotable et 1 plan de travail - couleur noyer ou wengé - roues multidirectionnelles  $\varnothing$  75 mm. Bacs non compris - les températures de travail indiquées sont à considérer avec couvercles en place.

EN Wooden heated bain-marie display with dome. Multi-layered birch wood structure - half-round Plexiglas dome - electric heating element - available with 1 foldable shelf and 1 support base - walnut or wengé colour - multidirectional wheels  $\varnothing$  75 mm. Containers not included - the operating temperatures listed are to be considered with lids on.

DE Bain-Marie Heizvitrine aus Holz mit Haube. Birkensperrholzstruktur - halbrunde Plexiglashaube - mit elektrischem Heizstab beheizt - mit 1 Faltfläche und 1 Ablagefläche - erhältlich in Walnuss oder Wenge - Mehrwegräder  $\varnothing$  75 mm. Behälter nicht enthalten - die angegebenen Arbeitstemperaturen sind bei aufgesetzten Deckeln zu verstehen.

	ELC 2834 noce-walnut	ELC 2834W wengé	ELC 2834B bianco-white
	2000 W		
	230V - 50Hz		
	+30°C +90°C		
	4 x GN1/1 - 150(h) mm		
	2030 €		2230 €

**+5%**

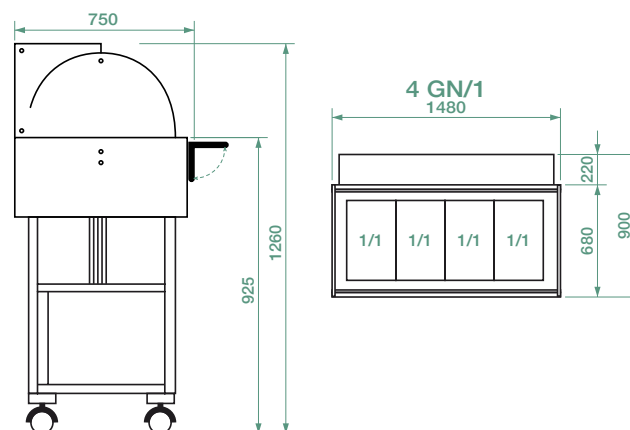

## ELC 2828



IT Espositore termico a bagnomaria in legno, con luce al neon. Struttura in legno multistrato di betulla - cupola in plexiglass - luce al neon - riscaldato con resistenza elettrica - disponibili con 2 mensole ripieghevoli - colore noce o wengé - ruote multidirezionali ø 75 mm. Bacinelle escluse - le temperature di lavoro indicate sono da considerarsi con coperchi posizionati.

EN Wooden heated bain-marie display with neon light. Multi-layered birch wood structure - half-round Plexiglas dome - neon light - electric heating element - available with two foldable shelves - walnut or wengé colour - multidirectional wheels ø 75 mm. Containers not included - the operating temperatures listed are to be considered with lids on.

## ELC 2828W



FR Présentoir bain-marie chauffants en bois, avec lampe néon. Structure en multicouche de bouleau - clochette en plexiglas - lampe néon - chauffé par résistance électrique - disponibles avec 2 étagères escamotables - couleur noyer ou wengé - roues multidirectionnelles ø 75 mm. Bacs non compris - les températures de travail indiquées sont à considérer avec couvercles en place.

DE Bain-Marie Heizvitrine aus Holz mit Neonlampe. Birkensperrholzstruktur - Plexiglashaube - Neonlampe - mit elektrischem Heizstab beheizt - mit 2 Faltflächen- erhältlich in Walnuss oder Wenge - Mehrwegräder ø 75 mm. Behälter nicht enthalten - die angegebenen Arbeitstemperaturen sind bei aufgesetzten Deckeln zu verstehen.

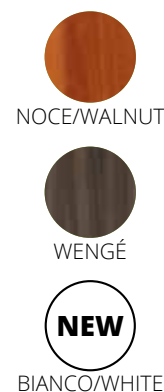

	ELC 2828 noce-walnut	ELC 2828W wengé	ELC 2828B bianco-white
	2000 W		
	230V - 50Hz		
	+30°C +90°C		
	4 x GN1/1 - 150(h) mm		
	2150 €		2350 €

+5%

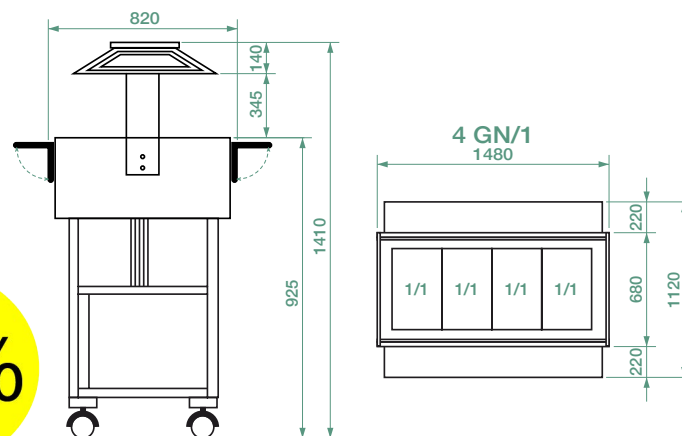

OPTIONAL



## ELN 2835

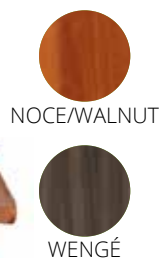

- IT** Espositore in legno neutro. Struttura in multistrato di betulla - cupola in plexiglas - piano in acciaio inox **AISI 304** - dotato di 2 mensole ripieghevoli - ruote multidirezionali ø 75 mm.
- EN** Display in neutral wood. Multi-layered birch wood structure - Plexiglas dome - top in stainless steel **AISI 304** - with 2 folding shelves - multidirectional wheels ø 75 mm.
- FR** Présentoir en bois neutre. Structure en en bouleau multicouche - clochette en plexiglas - plan de travail en acier inox **AISI 304** - avec 2 étagères escamotables - roues multidirectionnelles ø 75 mm.
- DE** Neutral Vitrine aus Holz. Birkenperrholzstruktur - Plexiglashaube - Fläche aus Edelstahl **AISI 304** - mit 2 faltflächen - Mehrwegräder ø 75 mm.

	ELN 2835 noce-walnut	ELN 2835W wengé
	147 x 82 x 141(h) cm	
	1700 €	

## CL2770N

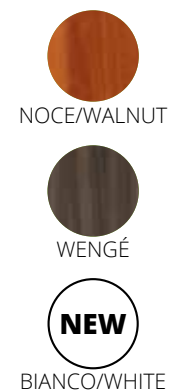

CL 2770

- IT** Carrello termico in legno, ideale per bolliti e arrostiti. Struttura portante in legno multistrato di betulla - vasca in acciaio inox **AISI 304** munita di scarico. Bacinelle escluse
- EN** Wooden heated trolley, ideal for boiled and roasted meats. Multi-layered birch wood structure - stainless steel **AISI 304** bowl with drain. Containers not included.
- FR** Chariot chauffant en bois, idéal pour les viandes bouillies et rôties. Structure portante en multicouche de bouleau - cuve en acier inox **AISI 304** avec vidange. Bacs non compris
- DE** Heizwagen aus Holz, ideal für gekochtes und gebratenes Fleisch. Birkenperrholztragstruktur - Becken aus Edelstahl **AISI 304** mit Ablauf. Behälter nicht enthalten

	CL 2770N noce-walnut	CL 2770NW wengé	CL 2770NB bianco-white
	2000 W		
	230V - 50Hz		
	+30°C +90°C		
	3x GN/1/1 150(h) mm		
	123 x 65 x 95(h) cm		
	1450 €	1600 €	

Carrello termico, ideale per bolliti e arrostiti  
Heated trolley, ideal for boiled and roasted meats



## Carrelli di servizio in legno Wooden service trolleys

	<b>CLR311</b>
<b>Mod.</b>	CLR 2788 - 2787 - 2786 - 2777 - 2778 2774 - 2772 - 2770
	Vasca inox forata Stainless steel perforated container Bac inox perforée Behälter aus rostfreiem Stahl mit Löcher
	<b>GN3x1/1 - 100(h) mm</b>
	<b>130 €</b>

	<b>CF411</b>
<b>Mod.</b>	ELR 2827 - 2826 - 2825 - 2832 2834 - 2828 - 2835
	Vasca inox forata Perforated stainless steel bowl Cuve perforée en acier inox Gelochte Edelstahlwanne
	<b>GN3x1/1 - 100(h) mm</b>
	<b>150 €</b>

**+5%**

### Solo per modello CL2770 For CL2770 model only

<b>A 580</b>
Portacoperchi inox Stainless steel lid holder Porte-couvercle en acier inox Edelstahl-Deckelhalter
<b>96 €</b>

<b>A 590</b>
Portacoltelli Knives holder Porte-couteaux Messerhalter
<b>55 €</b>

<b>A 600</b>
Scorrevole portapiatti con tagliere polietilene Sliding plate holder with polyethylene chopping board Porte-plat coulissant avec planche en polyéthylène Gleitplattenhalter mit Polyethylen-Schneidebrett
<b>140 €</b>

# Mensole in legno per unione

CONNECTION WOODEN SHELF - ÉTAGÈRES EN BOIS POUR RACCORDS - VERBINDUNGSREGALE AUS HOLZ

## MLUN



## ANUN

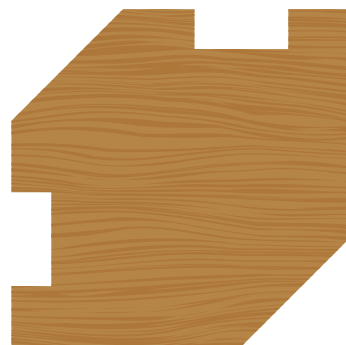

## MLUNW

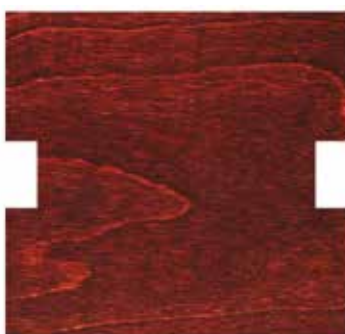

## ANUNW



PER MODELLI / FOR MODEL			
CLR 2782			CL 2770
CLR 2784	ELR 2825	ELC 2828	CL 2772
CLR 2786	ELR 2826	ELC 2832	CL 2774
CLR 2787	ELR 2827	ELC 284	CL 2777
CLR 2788			CL 2778

	MLUN	MLUNW	ANUN	ANUNW
				
	68 x 70 cm		88 x 88 cm	
	130 €		160 €	

**+5%**

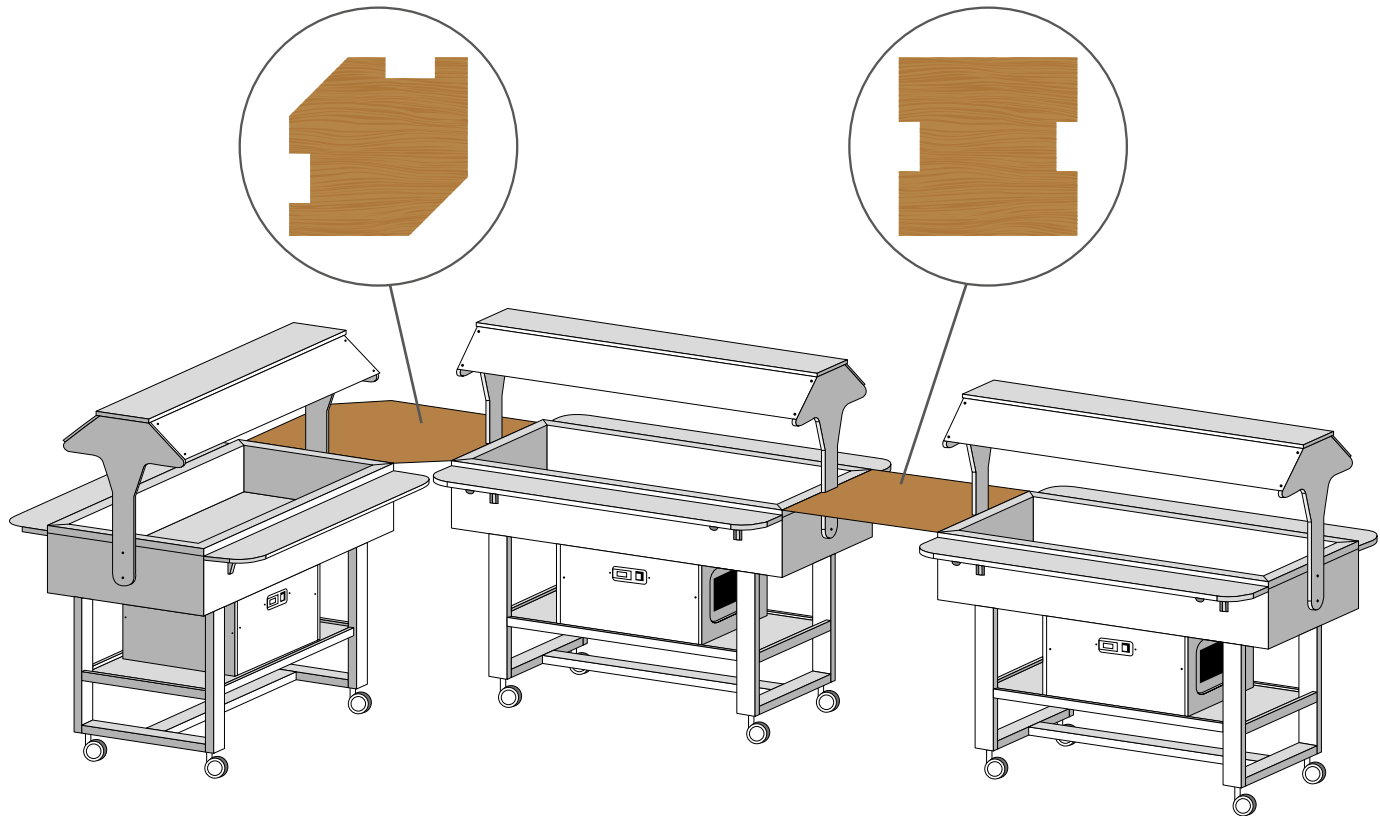
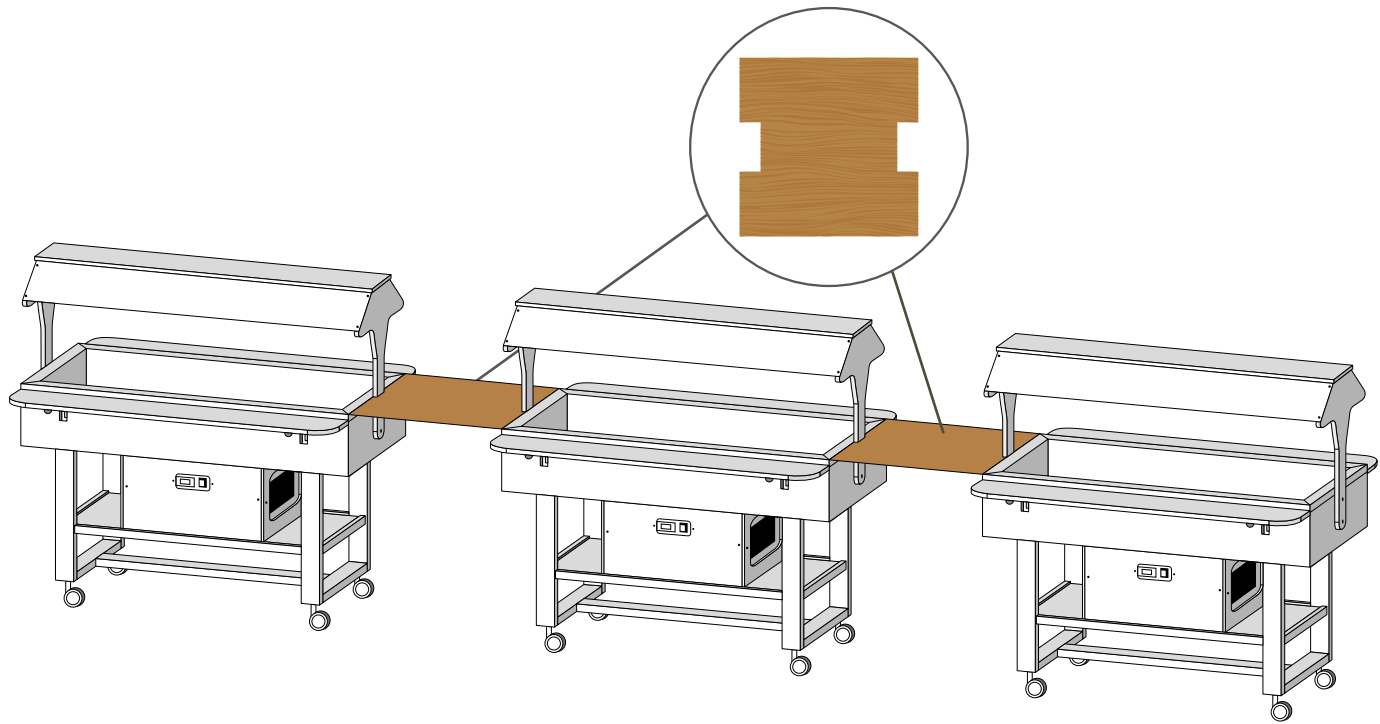



# Carrelli, vasche e distributori in acciaio inox

STAINLESS STEEL TROLLEYS,  
BOWLS AND DISPENSERS.  
CHARIOTS, CUVES ET DISTRIBUTEURS  
EN ACIER INOX  
WAGEN, WANNEN UND SPENDER  
AUS EDELSTAHL

# G-VRI211 - G-VRI311 G-VRI411 - G-VRI311F G-VRI411F



IT Vasche refrigerate da incasso in acciaio inox **AISI 304**. Struttura in acciaio inox **AISI 304** - spessore isolamenti 50 mm - refrigerazione statica - gruppo incorporato nel vano inferiore - controllo temperatura elettronico con termostato digitale - sbrinamento automatico - evaporazione dell'acqua di condensa automatica.

EN Stainless steel **AISI 304** refrigerated bowls. Stainless steel **AISI 304** structure - 50 mm insulation thickness - static refrigeration - built-in control unit in the lower compartment - electronic temperature control with digital thermostat - automatic defrosting - automatic evaporation of condensation water.

FR Cuves réfrigérées en acier inox **AISI 304**. Structure en acier inox **AISI 304** - épaisseur d'isolation de 50 mm - réfrigération statique - unité incorporée dans le compartiment inférieur - régulation électronique de température avec thermostat digital - dégivrage automatique - évaporation automatique de l'eau de condensation.

DE Kühlwannen aus Edelstahl **AISI 304**. Struktur aus Edelstahl **AISI 304** - 50 mm Isolierstärke - statische Kühlung - Einbaueinheit im unteren Fach - elektronische Temperaturregelung mit digitalem Thermostat - automatische Abtauung - automatische Kondensatverdampfung.

VRI

**+5%**

i	G-VRI211	G-VRI311	G-VRI411	G-VRI311F	G-VRI411F
⚡	340 W				
🔌 1 Ph	220/240V 50HZ				
🌡️	+2°C +8°C			-5°C +5°C	
N.	2 x GN1/1 - 150(h) mm	3 x GN1/1 - 150(h) mm	4 x GN1/1 - 150(h) mm	3 x GN1/1 - 150(h) mm	4 x GN1/1 - 150(h) mm
	1000 €	1100 €	1150 €	1360 €	1490 €

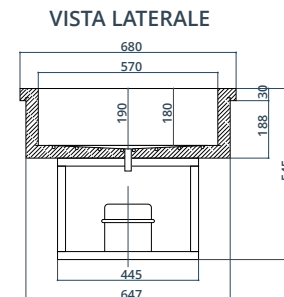
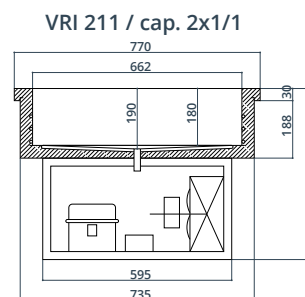
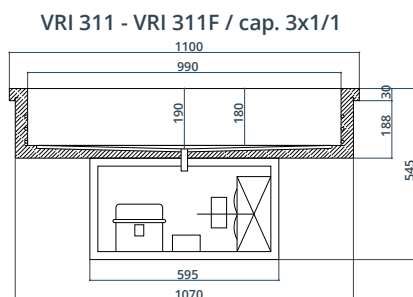
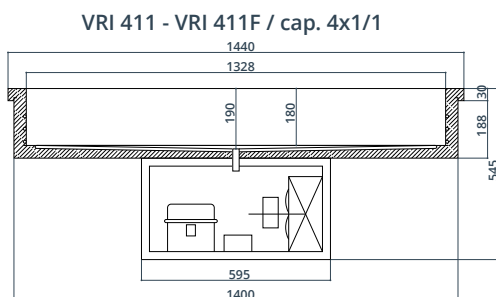

Vasche refrigerate in acciaio inox **AISI 304** ad incasso  
Recessed stainless steel **AISI 304** refrigerated bowls

# VBC 211 - VBC 311 VBC 411





IT Vasche termiche da incasso a bagnomaria in acciaio inox **AISI 304**. Vasca dotata di scarico acqua - controllo temperatura elettronico con termostato digitale.

EN Stainless steel **AISI 304** heated Bain-marie bowls. Bowl with water drain - electronic temperature control with digital thermostat.

FR Cuves bain-marie en acier inox **AISI 304**. Cuve équipée de vidange d'eau - régulation électronique de la température avec thermostat digital.

DE Bain-Marie Heizwannen aus Edelstahl **AISI 304**. Wanne mit Wasserablauf - elektronische Temperaturregelung mit digitalem Thermostat.



	VBC 211	VBC 311	VBC 411
	2000 W		
 1 Ph	220/240V 50HZ		
	+30°C +90°C		
	2 x GN1/1 - 150(h) mm	3 x GN1/1 - 150(h) mm	4 x GN1/1 - 150(h) mm
	550 €	600 €	650 €

VBC

**+5%**

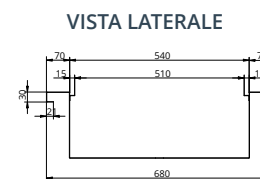
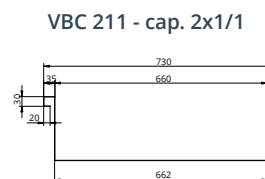
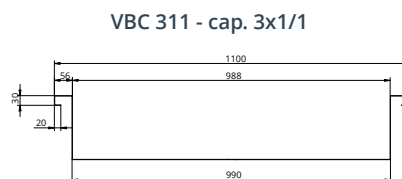
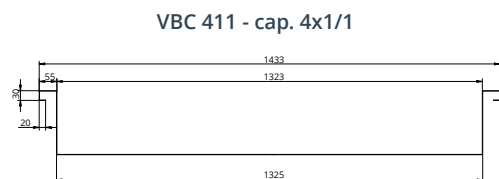

Vasche termiche a bagnomaria in acciaio inox **AISI 304**  
Stainless steel **AISI 304** heated Bain-marie bowls

**forcar**

## CAR 2779









IT Carrello refrigerato in acciaio inox. Struttura in acciaio inox **AISI 304** - refrigerazione statica - maniglia direzionale - ruote multidirezionali Ø 125 mm. Bacinelle escluse - le temperature di lavoro indicate sono da considerarsi con coperchi posizionati.

EN Stainless steel refrigerated trolley. Stainless steel **AISI 304** structure - static refrigeration - directional handle - multidirectional wheels Ø 125 mm. Containers not included - the operating temperatures listed are to be considered with lids on.

FR Chariot réfrigéré en acier inox. Structure en acier inox **AISI 304** - réfrigération statique - poignée directionnelle - roues multidirectionnelles Ø 125 mm. Bacs non compris - les températures de travail indiquées sont à considérer avec couvercles en place.

DE Kühlwagen aus Edelstahl. Struktur Edelstahl **AISI 304** - statische Kühlung - Lenkgriff - Mehrwegräder Ø 125 mm. Behälter nicht enthalten - die angegebenen Arbeitstemperaturen sind bei aufgesetzten Deckeln zu verstehen.







	CAR 2779	
	250 W	
	230V/1N/ 50HZ	
	R600a	
	+2°C +10°C	
	3 x GN1/1 - 150(h) mm	
	124 x 72 x 94(h) cm	
	<b>2150 €</b>	

## CAR 2780 - CAR 2780BT



CAR 2780

**+5%**

	CAR 2780	CAR 2780BT
	250 W	
	230V/1N/ 50HZ	
	R600a	
	+2°C +10°C	-5°C +5°C
	3 x GN1/1 - 150(h) mm	
	124 x 72 x 126(h) cm	
	<b>2480 €</b>	<b>2700 €</b>

Carrelli refrigerati in acciaio inox **AISI 304**  
Stainless steel **AISI 304** refrigerated trolleys

# CT 1760C









CT 1760C  
CON CUPOLA SEMICIRCOLARE / WITH SEMICIRCULAR CAP

IT Carrelli termici a bagnomaria. Struttura in acciaio inox **AISI 304** - vasca a doppia parete provvista di rubinetto di scarico posto sul fondo - termostato regolabile - maniglia direzionale - paracolpi - ruote multidirezionali ø 125 mm. Bacinelle escluse - le temperature di lavoro indicate sono da considerarsi con coperchi posizionati.

EN Bain-marie heated trolleys. Stainless steel **AISI 304** structure - double walled bowl with drain valve fitted at the bottom - adjustable thermostat - directional handle - shock absorber - multidirectional wheels ø 125 mm. Containers not included - the operating temperatures listed are to be considered with lids on.

FR Chariots chauffants bain-marie. Structure en acier inox **AISI 304** - cuve à double paroi équipée d'un robinet de vidange en bas - thermostat réglable - poignée directionnelle - butoirs - roues multidirectionnelles ø 125 mm. Bacs non compris - les températures de travail indiquées sont à considérer avec couvercles en place.

DE Bain-Marie Heizwagen Struktur aus Edelstahl **AISI 304** - Doppelwandige Wanne mit einem Ablasshahn im Unterteil - einstellbarer Thermostat - Lenkergriff - Stoßschutz - Mehrwegräder ø 125 mm. Behälter nicht enthalten - die angegebenen Arbeitstemperaturen sind bei aufgesetzten Deckeln zu verstehen.

	CT 1760C
	2000 W
 1 Ph	230V/ 50-60 HZ
	+30° +90°C
 N.	3 x GN1/1 - 200(h) mm
 cm	117 x 67 x 114(h) cm
	1150 €

+5%



# CT 1758TD - CT 1760TD









CT 1760TD

IT Carrelli termici a bagnomaria con temperature differenziate in acciaio inox **AISI 304**. Struttura in acciaio inox **AISI 304** - vasca a doppia parete provvista di rubinetto di scarico posto sul fondo - termostato regolabile - maniglia direzionale - paracolpi - ruote multidirezionali  $\varnothing$  125 mm. Bacinelle escluse - le temperature di lavoro indicate sono da considerarsi con coperchi posizionati.

EN Stainless steel **AISI 304** Bain-marie heated trolleys with separate temperatures. Stainless steel **AISI 304** structure - double walled bowl with drain valve fitted at the bottom - adjustable thermostat - directional handle - shock absorber - multidirectional wheels  $\varnothing$  125 mm. Containers not included - the operating temperatures listed are to be considered with lids on.

FR Chariots chauffants bain-marie à températures différenciées en acier inox **AISI 304**. Structure en acier inox **AISI 304** - cuve à double paroi équipée d'un robinet de vidange en bas - thermostat réglable - poignée directionnelle - butoirs - roues multidirectionnelles  $\varnothing$  125 mm. Bacs non compris - les températures de travail indiquées sont à considérer avec couvercles en place.

DE Bain-Marie Heizwagen mit unterschiedlichen Temperaturen aus Edelstahl **AISI 304**. Struktur aus Edelstahl **AISI 304** - Doppelwandige Wanne ausgestattet mit einem unten angebrachten Ablaufventil - einstellbarer Thermostat - Lenkergriff - Stoßschutz - Mehrwegräder  $\varnothing$  125 mm. Behälter nicht enthalten - die angegebenen Arbeitstemperaturen sind bei aufgesetzten Deckeln zu verstehen.

	CT 1758TD	CT 1760TD
	2000 W	3000 W
 1 Ph	230V/ 50-60 HZ	
	+30° +90°C	
 N.	2 x GN1/1 - 150(h) mm	3 x GN1/1 - 150(h) mm
 cm	84 x 65 x 85(h) cm	117 x 67 x 85(h) cm
	820 €	1020 €

+5%

# CT 1765 - CT 1770



CT 1765

**IT** Carrelli termici a bagnomaria armadiati. Struttura in acciaio inox **AISI 304** - vano superiore in doppia parete coibentata - coperchi apribili a compasso fino a 180° per formare un piano di appoggio. provvisti di rubinetto di scarico posto sul fondo - 2 ruote fisse e 2 multidirezionali ø 140 mm. Bacinelle escluse - le temperature di lavoro indicate sono da considerarsi con coperchi posizionati.

**EN** Bain-marie heated trolleys on counters. Structure in **AISI 304** stainless steel - insulated double-walled upper compartment - lids that can be opened up to 180° to form a support surface. Equipped with a drain valve on the bottom - 2 fixed wheels and 2 multidirectional wheels ø 140 mm. Containers not included - the operating temperatures listed are to be considered with lids on.

**FR** Chariots chauffants bain-marie sur meublé fermé. Structure en acier inox **AISI 304** - compartiment supérieur en double paroi isolée - couvercles pouvant s'ouvrir jusqu'à 180° pour former une surface d'appui - 2 roues fixes et 2 roues multidirectionnelles ø 140 mm, équipées d'un robinet de vidange placé en bas. Bacs non compris - les températures de travail indiquées sont à considérer avec couvercles en place.

**DE** Bain-Marie Heizwagen mit Schrankelement. Struktur aus Edelstahl **AISI 304** - oberes Fach mit isoliertem Doppelwand - Deckel bis zu 180° öffnungsfähig, um eine Auflagefläche zu bilden, ausgestattet mit einem unten angebrachten Ablaufventil - 2 feste Räder und 2 Mehrwegräder ø 140 mm. Behälter nicht enthalten - die angegebenen Arbeitstemperaturen sind bei aufgesetzten Deckeln zu verstehen.



CT 1770

**+5%**

	CT 1765	CT 1770
	2000 W	
	230V/ 50-60 HZ	
	+30° +90°C	
	2 x GN1/1 - 200(h) mm	3 x GN1/1 - 200(h) mm
	96 x 68 x 102(h) cm	130 x 68 x 102(h) cm
	1900 €	2100 €

# CT 1766 - CT 1771









CT1771

**IT** Carrelli termici a bagnomaria armadiati. Struttura in acciaio inox **AISI 304** - vano superiore in doppia parete coibentata - provvisti di rubinetto di scarico posto sul fondo - 2 ruote fisse e 2 multidirezionali ø 140 mm. Bacinelle escluse.

**EN** Bain-marie heated trolleys on counters. Structure in **AISI 304** stainless steel - insulated double-walled upper compartment - equipped with a drain valve on the bottom - 2 fixed wheels and 2 multidirectional wheels ø 140 mm. Containers not included.

**FR** Chariots chauffantes bain-marie sur meublé fermé. Structure en acier inox **AISI 304** - compartiment supérieur en double paroi isolée - 2 roues fixes et 2 roues multidirectionnelles ø 140 mm, équipées d'un robinet de vidange placé en bas. Bacs non compris.

**DE** Bain-Marie Heizwagen mit Schrankelement. Struktur aus Edelstahl **AISI 304** - oberes Fach mit isoliertem Doppelwand - ausgestattet mit einem unten angebrachten Ablaufventil - 2 feste Räder und 2 Mehrwegräder ø 140 mm. Behälter nicht enthalten.

	CT 1766	CT 1771
	2000 W	
 1 Ph	230V/ 50-60 HZ	
	+30° +90°C	
	2 x GN1/1 - 200(h) mm	3 x GN1/1 - 200(h) mm
	96 x 68 x 92(h) cm	130 x 68 x 92(h) cm
	1600 €	1750 €

OPTIONAL



**+5%**



# CT 1765TD - CT 1770TD



CT 1765TD









**IT** Carrelli termici a bagnomaria armadiati con temperatura differenziata. Struttura in acciaio inox **AISI 304** - vano superiore in doppia parete coibentata - coperchi apribili a compasso fino a 180° per formare un piano di appoggio. provvisti di rubinetto di scarico posto sul fondo - 2 ruote fisse e 2 multidirezionali ø 140 mm. Bacinelle escluse - le temperature di lavoro indicate sono da considerarsi con coperchi posizionati.

**EN** Bain-marie heated trolleys on counters with differentiated temperature. Structure in **AISI 304** stainless steel - insulated double-walled upper compartment - lids that can be opened up to 180° to form a support surface. Equipped with a drain valve on the bottom - 2 fixed wheels and 2 multidirectional wheels ø 140 mm. Containers not included - the operating temperatures listed are to be considered with lids on.

**FR** Chariots bain-marie chauffés à température différenciée. Structure en acier inox **AISI 304** - compartiment supérieur en double paroi isolée - couvercles pouvant s'ouvrir jusqu'à 180° pour former une surface d'appui - 2 roues fixes et 2 roues multidirectionnelles ø 140 mm, équipées d'un robinet de vidange placé en bas. Bacs non compris - les températures de travail indiquées sont à considérer avec couvercles en place.

**DE** Bain-Marie Heizwagen mit Schrankelement mit unterschiedlichen Temperaturen. Struktur aus Edelstahl **AISI 304** - oberes Fach in isolierter Doppelwand - Deckel bis zu 180° öffnungsfähig, um eine Auflagefläche zu bilden, ausgestattet mit einem unten angebrachten Ablaufventil - 2 feste Räder und 2 Mehrwegräder ø 140 mm. Behälter nicht enthalten - die angegebenen Arbeitstemperaturen sind bei aufgesetzten Deckeln zu verstehen.

**+5%**

	CT 1765TD	CT 1770TD
		
	2000 W	3000 W
	230V/ 50-60 HZ	
	+30° +90°C	
	2 x GN1/1 - 150(h) mm	3 x GN1/1 - 150(h) mm
	96 x 68 x 102(h) cm	130 x 68 x 102(h) cm
	2050 €	2400 €

# CT 1766TD - CT 1771TD









CT 1771TD

**IT** Carrelli termici a bagnomaria armadiati con temperatura differenziata. Struttura in acciaio inox **AISI 304** - vano superiore in doppia parete coibentata - provvisti di rubinetto di scarico posto sul fondo - 2 ruote fisse e 2 multidirezionali ø 140 mm. Bacinelle escluse.

**EN** Bain-marie heated trolleys on counters with differentiated temperature. Structure in **AISI 304** stainless steel - insulated double-walled upper compartment - Equipped with a drain valve on the bottom - 2 fixed wheels and 2 multidirectional wheels ø 140 mm. Containers not included.

**FR** Bain-marie heated trolleys on counters with differentiated temperature. Structure in **AISI 304** stainless steel - insulated double-walled upper compartment - équipée d'un robinet de vidange en bas - 2 roues fixes et 2 roues multidirectionnelles ø 140 mm. Bacs non compris.

**DE** Bain-Marie Heizwagen mit Schrankelement mit unterschiedlichen Temperaturen. Struktur aus Edelstahl **AISI 304** - oberes Fach in isolierter Doppelwand - ausgestattet mit einem unten angebrachten Ablaufventil - 2 feste Räder und 2 Mehrwegräder ø 140 mm. Behälter nicht enthalten.

	CT 1766TD	CT 1771TD
	2000 W	3000 W
 1 Ph	230V/ 50-60 HZ	
	+30° +90°C	
 N.	2 x GN1/1 - 150(h) mm	3 x GN1/1 - 150(h) mm
 cm	96 x 68 x 92(h) cm	130 x 68 x 92(h) cm
	1750 €	2150 €

OPTIONAL



**+5%**



# CS 1751 - CS 1753 CS 1755



CS 1751

IT Carrelli termici scalda tegamini/biberon. Struttura in acciaio inox **AISI 304** - vasca a doppia parete provvista di rubinetto di scarico posto sul fondo - termostato regolabile - maniglia direzionale - ruote multidirezionali Ø 125 mm. Le temperature di lavoro indicate sono da considerarsi con coperchi posizionati.

EN Heated trolleys for small pans and baby bottles heating. Stainless steel **AISI 304** structure - double walled bowl with drain valve fitted at the bottom - adjustable thermostat - directional handle - multidirectional wheels Ø 125 mm. The operating temperatures listed are to be considered with lids on.

FR Chariots chauffants pour réchauffer petit récipients ou biberon. Structure en acier inox **AISI 304** - cuve à double paroi équipée d'un robinet de vidange en bas - thermostat réglable - poignée directionnelle - roues multidirectionnelles Ø 125 mm. Les températures de travail indiquées sont à considérer avec couvercles en place.

DE Heizwagen für Pfannen- und Babyflaschenerwärmung. Struktur aus Edelstahl **AISI 304** - Doppelwandige Wanne ausgestattet mit einem unten angebrachten Ablaufventil - einstellbarer Thermostat - Lenkergriff - Mehrwegräder Ø 125 mm. Die angegebenen Arbeitstemperaturen sind bei aufgesetzten Deckeln zu verstehen.

+5%

A BAGNOMARIA / BAIN MARIE			
i	CS 1751	CS 1753	CS 1755
⚡	2000 W		
🔌 1 Ph	230V/ 50-60 HZ		
🌡️	+30° +90°C		
📏 cm	30 x 50 cm	51 x 62 cm	51 x 96 cm
📏 cm	56 x 65 x 85(h) cm	84 x 65 x 85(h) cm	117 x 65 x 85(h) cm
	750 €	850 €	900 €

CT 1756 - CTS 1757  
 CT 1758 - CTS 1759  
 CT 1760 - CTS 1761  
 CT 1762









CT 1756

IT Carrelli termici. Struttura in acciaio inox **AISI 304** - vasca a doppia parete - termostato regolabile - maniglia direzionale - ruote multidirezionali Ø 125 mm. Bacinelle escluse - le temperature di lavoro indicate sono da considerarsi con coperchi posizionati.

EN Heated trolleys. Stainless steel **AISI 304** structure - double walled bowl - adjustable thermostat - directional handle - multidirectional wheels Ø 125 mm. Containers not included - the operating temperatures listed are to be considered with lids on.

FR Chariots chauffants. Structure en acier inox **AISI 304** - cuve à double paroi - thermostat réglable - poignée directionnelle - roues multidirectionnelles Ø 125 mm. Bacs non compris - les températures de travail indiquées sont à considérer avec couvercles en place.

DE Heizwagen. Struktur aus Edelstahl **AISI 304** - Doppelwandige Wanne - einstellbarer Thermostat - Lenkergriff - Mehrwegräder Ø 125 mm. Behälter nicht enthalten - die angegebenen Arbeitstemperaturen sind bei aufgesetzten Deckeln zu verstehen.

	A BAGNOMARIA / BAIN MARIE				CON RESISTENZA A SECCO / WITH DRY HEATING ELEMENT		
	CT 1756	CT 1758	CT 1760	CT 1762	CTS 1757	CTS 1759	CTS 1761
	2000 W				1000 W	2000 W	
	230V/ 50-60 HZ						
	+30° +90°C						
	1 x GN1/1 - 200(h) mm	2 x GN1/1 - 200(h) mm	3 x GN1/1 - 200(h) mm	4 x GN1/1 - 200(h) mm	1 x GN1/1 - 200(h) mm	2 x GN1/1 - 200(h) mm	3 x GN1/1 - 200(h) mm
	56 x 65 x 85(h) cm	84 x 65 x 85(h) cm	117 x 65 x 85(h) cm	148 x 65 x 85(h) cm	56 x 65 x 85(h) cm	84 x 65 x 85(h) cm	117 x 65 x 85(h) cm
	650 €	740 €	800 €	950 €	650 €	700 €	800 €

Carrelli termici in acciaio inox **AISI 304**  
 Stainless steel **AISI 304** heated trolley

**+5%**

# DCM 1699 DCM 1701



DCM 1699

**IT** Distributori per prime colazioni. Struttura interamente in acciaio inox **AISI 304** 18/10 - vasca doppia parete - recipienti in acciaio inox **AISI 304** 18/10 da L 15 cad. complete di coperchio - rubinetti in plastica facilmente rimovibili - termostato regolabile - disponibili nella versione con mobiletto di sostegno in acciaio inox **AISI 304** con anta battente - ripiano intermedio - ruote multidirezionali da Ø 95 mm, oppure nella versione da appoggio.

**EN** Breakfast dispensers. Structure entirely in stainless steel **AISI 304** 18/10 - double-walled bowl - containers in stainless steel **AISI 304** 18/10 of 15 L each, with lid - easily removable plastic taps - adjustable thermostat - available in the version with support unit in stainless steel **AISI 304** with hinged door - intermediate shelf - Ø 95 mm multidirectional wheels, or in the countertop version.

# DC 1704 - DC 1703



DC 1704

**FR** Distributeurs pour le petit déjeuner. Structure entièrement en acier inox **AISI 304** 18/10 - cuve à double paroi - cuves en acier inox **AISI 304** 18/10 de 15 L chacune avec couvercle - robinets en plastique facilement démontables - thermostat réglable - disponible dans la version avec armoire en acier inox **AISI 304** avec porte battante - étagère intermédiaire - roues multidirectionnelles Ø 95 mm ou en version de table.

**DE** Frühstücksspender. Gehäuse vollständig aus Edelstahl **AISI 304** 18/10 - doppelwandige Wanne - Behälter aus Edelstahl **AISI 304** 18/10 je 15 L mit Deckel - leicht abnehmbare Kunststoffhähne - einstellbarer Thermostat - erhältlich in der Ausführung mit Stützschränk aus Edelstahl **AISI 304** mit Flügeltür - Zwischenboden - Ø 95 mm Mehrwegräder, oder als Tisch Version.

	DCM 1699	DCM 1701
	2000 W	
	230V/ 50-60 HZ	
	+30° +90°C	
	2 recipienti da 15 L 2 tanks 15 L	3 recipienti da 15 L 3 tanks 15 L
	75 x 41 x 135(h) cm	106 x 41 x 135(h) cm
	2400 €	3000 €

	DC 1704	DC 1703
	2000 W	
	230V/ 50-60 HZ	
	+30° +90°C	
	2 recipienti da 15 L 2 tanks 15 L	3 recipienti da 15 L 3 tanks 15 L
	75 x 41 x 71(h) cm	106 x 41 x 71(h) cm
	1700 €	2200 €



## Carrelli termici Heated Trolleys

	<b>A700</b>
<b>Mod.</b>	CT1770 - CT1771 - CT1770TD - CT1771TD
	Vano inferiore riscaldato Heated lower compartment Compartment inferieur chauffé Beheiztes Unterfach
	<b>180 €</b>

	<b>A650</b>
<b>Mod.</b>	CT1765 - CT1766 - CT1766TD - CT1765TD
	Vano inferiore riscaldato Heated lower compartment Compartment inferieur chauffé Beheiztes Unterfach
	<b>180 €</b>

**+5%**



Optional



# Elementi riscaldanti e vetrine neutre

HEATING ELEMENTS  
AND NEUTRAL DISPLAYS  
ÉLÉMENTS CHAUFFANTS  
ET VITRINES NEUTRES  
HEIZELEMENTE  
UND NEUTRALE VITRINEN

## BM 1780 - BM 1782 BM 1784 - BM 1786



## BMS 1781 - BMS 1783 BMS 1785



BM 1784

BMS 1785

IT Tavole calde a bagnomaria. Struttura in acciaio inox **AISI 304** - parete coibentata - rubinetto di scarico - termostato regolabile. Le bacinelle sono escluse.

IT Tavole calde con resistenza a secco (senza acqua). Struttura in acciaio inox **AISI 304** - parete coibentata- termostato regolabile. Le bacinelle sono escluse.

EN Bain-marie heated tables. Stainless steel **AISI 304** structure - insulated wall - drain valve- adjustable thermostat. Containers not included.





EN Heated tables with dry heating element (without water). Stainless steel **AISI 304** structure - insulated wall - adjustable thermostat. Containers not included.







FR Tables chaudes avec bain-marie . Structure en acier inox **AISI 304** - paroi isolée - robinet de vidange - thermostat réglable. Les bacs ne sont pas compris.

FR Heated tables with dry heating element (without water). Stainless steel **AISI 304** structure - insulated wall - adjustable thermostat. Containers not included.

DE Bain-Marie Heitzische. Struktur aus Edelstahl **AISI 304** - isolierte Wand - Ablaufventil - einstellbarer Thermostat. Behälter nicht enthalten.

DE Heitzische mit Trockenheizstab (ohne Wasser). Struktur aus Edelstahl **AISI 304** - isolierte Wand - einstellbarer Thermostat. Behälter nicht enthalten.

	BM 1780	BM 1782	BM 1784	BM 1786
	2000 W			
 1 Ph	230V/ 50-60 HZ			
	+30° +90°C			
	1 x GN1/1 200(h) mm	2 x GN1/1 200(h) mm	3 x GN1/1 200(h) mm	4 x GN1/1 200(h) mm
	49 x 60 x 32(h) cm	78 x 60 x 32(h) cm	110 x 60 x 32(h) cm	144 x 60 x 32(h) cm
	550 €	620 €	680 €	780 €

	BMS 1781	BMS 1783	BMS 1785
	1000 W		
 1 Ph	230V/ 50-60 HZ		
	+30° +90°C		
	1 x GN1/1 - 200(h) mm	2 x GN1/1 - 200(h) mm	3 x GN1/1 - 200(h) mm
	49 x 60 x 32(h) cm	78 x 60 x 32(h) cm	110 x 60 x 32(h) cm
	520 €	580 €	680 €

Tavole calde  
Heated tables

**+5%**

## BM 11 - BM 21 - BM 31



BM 11

IT Tavole calde a bagnomaria. Struttura in acciaio inox - termostato regolabile. Le bacinelle sono escluse.

EN Bain-marie heated tables. Stainless steel structure - adjustable thermostat. Containers not included.

FR Tables chaudes avec bain-marie . Structure en acier inox - thermostat réglable. Les bacs ne sont pas compris.

DE Bain-Marie Heitzische. Edelstahlstruktur - einstellbarer Thermostat. Behälter nicht enthalten.

## BMV 11 - BMV 21 BMV 31









BMV 21





IT Tavole calde a bagnomaria. Struttura in acciaio inox - rubinetto di scarico - temperature vasche differenziate - termostato regolabile. Le bacinelle sono escluse.

EN Bain-marie heated tables. Stainless steel structure - drain valve - differentiated bowl temperatures - adjustable thermostat. Containers not included.

FR Tables chaudes avec bain-marie . Structure en acier inox - robinet de vidange - différentes températures des cuves - thermostat réglable. Les bacs ne sont pas compris.

DE Bain-Marie Heitzische. Edelstahlstruktur - Ablaufventil - unterschiedliche Temperaturen - einstellbarer Thermostat. Behälter nicht enthalten.

	BM 11	BM 21	BM 31
	1200 W	1200 + 1200 W	1000 + 1000 + 1000 W
	230V/50-60 HZ		
	+30° +90°C		
	1 x GN1/1 - 150(h) mm	2 x GN1/1 - 150(h) mm	3 x GN1/1 - 150(h) mm
	54 x 33 x 22(h) cm	66 x 54 x 22(h) cm	99 x 54 x 22(h) cm
	280 €	430 €	560 €

	BMV 11	BMV 21	BMV 31
	1200 W	1200 + 1200 W	1000 + 1000 + 1000 W
	230V/50-60 HZ		
	+30° +90°C		
	1 x GN1/1 - 150(h) mm	2 x GN1/1 - 150(h) mm	3 x GN1/1 - 150(h) mm
	54 x 33 x 22(h) cm	66 x 54 x 22(h) cm	99 x 54 x 22(h) cm
	320 €	490 €	670 €

+5%

## BM 7700



IT Tavola calda a bagnomaria. Struttura in acciaio inox - bacinella esclusa

EN Bain-marie heated table. Stainless steel structure - containers not included

FR Table chaude avec bain-marie . Structure en acier inox - bacs pas compris.

DE Bain-Marie Heiztisch. Edelstahlstruktur - Behälter nicht enthalten

## BMP 7720













IT Tavola calda a bagnomaria. Struttura in acciaio inox - modello compreso di 2 pentole da 8 L.

EN Bain-marie heated table. Stainless steel structure - with 2 pans of 8 L.

FR Table chaude avec bain-marie . Structure en acier inox - modèle équipé de 2 marmites de 8 L.

DE Bain-Marie Heiztisch. Struktur aus Edelstahl - Modell mit 2 Kesseln 8 L je.

	BM 7700
	1200 W
	230V/ 50-60 HZ
	+30° +90°C
	1 x GN1/1 - 150(h) mm
	57 x 37 x 22(h) cm
	165 €

	BMP 7720
	1200 W
	230V/ 50-60 HZ
	+30° +90°C
	2 pentole 2 pots
	57 x 37 x 28(h) cm
	230 €

+5%

Tavole calde  
Heated tables

PC 4750 - PC 4752  
 PC 4754 - PC 5050  
 PC 6040 - PC 8060

PC 4754



- IT Piani caldi in acciaio inox. Struttura in acciaio inox **AISI 304** - termostato regolabile
- EN Hot plates in stainless steel. Stainless steel **AISI 304** structure - adjustable thermostat.
- FR Hot plates in stainless steel. Stainless steel **AISI 304** structure - adjustable thermostat.
- DE Heiße Edelstahlplatten. Struktur aus Edelstahl **AISI 304** - einstellbarer Thermostat.

PVC 4760 - PVC 4763  
 PVC 4765

PVC 4760



- IT Piani caldi con piano in vetro temperato. Struttura in acciaio inox **AISI 304** - termostato regolabile.
- EN Hot plates with tempered glass top. Stainless steel **AISI 304** structure - adjustable thermostat.
- FR Plaques chauffantes avec plan en verre trempé. Structure en acier inox **AISI 304** - thermostat réglable.
- DE Heiße Platten mit gehärteter Glasoberfläche. Struktur aus Edelstahl **AISI 304** - einstellbarer Thermostat.

i	PC 4750	PC 4752	PC 4754
⚡	250 W	450 W	600 W
1 Ph	230V/ 50-60 HZ		
🌡️	+30° +90°C		
↗️ cm	50 x 35 x 6(h) cm	90 x 45 x 6(h) cm	100 x 50 x 6(h) cm
	170 €	210 €	240 €

i	PVC 4760	PVC 4763	PVC4765
⚡	600 W		1000 W
1 Ph	230V/50-60 HZ		
🌡️	+30° +90°C		
↗️ cm	50 x 50 x 7(h) cm	60 x 40 x 7(h) cm	81 x 61 x 7(h) cm
	250 €	250 €	290 €

i	PC 5050	PC 6040	PC 8060
⚡	600 W		1000 W
1 Ph	230V/50-60 HZ		
🌡️	+30° +90°C		
↗️ cm	50 x 50 x 6(h) cm	60 x 40 x 6(h) cm	80 x 60 x 6(h) cm
	220 €	220 €	260 €

+5%

## PCC 4710 - PCC 4730



PCC 4710



PCC 4730

- IT Piani caldi con cupola in plexiglass. Struttura in acciaio inox **AISI 304** - termostato regolabile
- EN Hot plates with Plexiglas dome. Stainless steel **AISI 304** structure - adjustable thermostat.
- FR Plaques chauffantes avec clochette en plexiglas. Structure en acier inox **AISI 304** - thermostat réglable.
- DE Heiße Platten mit Plexiglashaube. Struktur aus Edelstahl **AISI 304** - einstellbarer Thermostat

	PCC 4710	PCC 4730
	450 W	600 W
	230V/ 50-60 HZ	230V/ 50-60 HZ
	+30° +90°C	
	90 x 45 x 20(h) cm	100 x 50 x 30(h) cm
	440 €	450 €

## PCI 4711 - PCI 4712 PCI 4713



PCI 4711

- IT Lampade a infrarossi con piano caldo in acciaio inox. Struttura in acciaio inox - termostato regolabile - copertura in policarbonato fumè.
- EN Infrared lamps with stainless steel heated plate. Stainless steel structure - adjustable thermostat - smoky grey polycarbonate lid.
- FR Lampes infrarouges avec plaque chaude en acier inox. Structure en acier inox - thermostat réglable - couvercle en polycarbonate fumé.
- DE Infrarot-Lampen mit Edelstahlwärmplatte. Struktur aus Edelstahl **AISI 304** - einstellbarer Thermostat - dunkle Polycarbonatabdeckung.

	PCI 4711	PCI 4712	PCI 4713
	250 +250 W	450 +500 W	600 +750 W
	230V/ 50-60 HZ		
	+30° +90°C		
	<b>1 lampada 1 lamp</b>	<b>2 lampade 2 lamps</b>	<b>3 lampade 3 lamps</b>
	45 x 64 x 80(h) cm	85 x 64 x 80(h) cm	127 x 68 x 80(h) cm
	400 €	510 €	640 €

Piani caldi  
Hot plates

**+5%**

Lampade a raggi infrarossi  
Infrared lamps

PI 4714 - PI 4715  
PI 4716

PIA 4714 - PIA 4715  
PIA 4716



PI4714



PIA 4716



PI4715



PIA4715

IT Telaio con lampade a infrarossi.

IT Telaio con lampade a infrarossi da appendere.

EN Frame with infrared lamps.





EN Frame with hanging infrared lamps.





FR Corps avec lampes infrarouges.

FR Corps avec lampes infrarouges suspendues.

DE Rahmen mit Infrarotlampen.

DE Rahmen mit hängenden Infrarotlampen.

	PI 4714	PI 4715	PI 4716
	250 W	500 W	750 W
 1 Ph	230V/ 50-60 HZ		
	+30° +90°C		
	<b>1 lampada 1 lamp</b>	<b>2 lampade 2 lamps</b>	<b>3 lampade 3 lamps</b>
	45 x 55 x 70(h) cm	85 x 55 x 70(h) cm	127 x 55 x 70(h) cm
	<b>250 €</b>	<b>330 €</b>	<b>420 €</b>

	PIA 4714	PIA 4715	PIA 4716
	250 W	500 W	750 W
 1 Ph	230V/ 50-60 HZ		
	+30° +90°C		
	<b>1 lampada 1 lamp</b>	<b>2 lampade 2 lamps</b>	<b>3 lampade 3 lamps</b>
	45 x 68 x 25(h) cm	85 x 68 x 25(h) cm	128 x 68 x 25(h) cm
	<b>190 €</b>	<b>260 €</b>	<b>350 €</b>

 Lampade a raggi infrarossi  
Infrared lamps

**+5%**

**forcar**



# PCI 4717 - PCI 4718 PCI 4718D



PCI 4717

PCI 4718





PCI 4718D

IT Lampade a infrarossi con piano caldo in acciaio inox, in diversi modelli. Struttura in acciaio inox e termostato regolabile.

EN Infrared lamps with stainless steel hot plate, in different models. Stainless steel structure and adjustable thermostat.

FR Lampes infrarouges avec plaque chauffante en acier inox, en différents modèles. Structure en acier inox et thermostat réglable.

DE Infrarotlampen mit Heizplatte aus Edelstahl, in verschiedenen Ausführungen. Edelstahlstruktur und einstellbarer Thermostat.

	PCI 4717	PCI 4718	PCI 4718D
	250 + 250 + 250 W	250 + 250 W	250 + 250 + 250 W
 1 Ph	230V/ 50-60 HZ		
	+30° +90°C		
	<b>2 lampade 2 lamps</b>	<b>1 lampada 1 lamp</b>	<b>2 lampade 2 lamps</b>
 cm	60 x 40 x 68(h) cm	58 x 33 x 68(h) cm	
	<b>450 €</b>	<b>320 €</b>	<b>410 €</b>

# BI 4719 - BI 4719D



BI 4719

BI 4719D

IT Lampade a infrarossi con contenitore Gastronorm GN1/1. Struttura in acciaio inox.

EN Infrared lamps with Gastronorm GN1/1 container. Stainless steel structure





FR Lampes infrarouges avec récipient Gastronorm GN1/1. Structure en acier inox.

DE Infrarotlampen mit Gastronorm-Behälter GN1/1. Edelstahlstruktur

**OPTIONAL  
A516**

Vasca riscaldata  
Heated bowl  
Cuve chauffée  
Beheizte Wanne

**85 €**

	BI 4719	BI 4719D
	250 W	
 1 Ph	230V/ 50-60 HZ	
	+30° +90°C	
	<b>1 lampada 1 lamp</b>	<b>2 lampade 2 lamps</b>
 cm	60 x 33 x 68(h) cm	
	<b>360 €</b>	<b>440 €</b>

Lampade a raggi infrarossi  
Infrared lamps

**+5%**

# VBR 4751 - VBR 4752 - VBR 4753 VBR 4781 - VBR 4782 - VBR 4783



VBR 4751



VBR 4752



VBR 4753

**IT** Vettrine riscaldate. Struttura in acciaio inox **AISI 304** - fianchi e antine sui due fronti in plexiglass trasparente - termostato regolabile - dispositivo di umidificazione.

**EN** Heated display cases. Structure in stainless steel **AISI 304** - Plexiglas sides and doors on both sides - adjustable thermostat - humidification device.

**FR** Vitrines chauffées. Structure en acier inox **AISI 304** - côtés et portes des deux côtés en plexiglas transparent - thermostat réglable - dispositif d'humidification.

**DE** Beheizte Vitrinen. Struktur aus Edelstahl **AISI 304** - Seiten und Türen auf beiden Seiten aus transparentem Plexiglas - einstellbarer Thermostat - Befeuchtungsvorrichtung.

**OPTIONAL**  
PRI50 - 250 W  
VBR4751 - VBR4752 - VBR4753 - VBR4756







Piano intermedio riscaldato  
Heated intermediate shelf  
Étagère intermédiaire chauffée  
Beheiztes Zwischenfach

145 €

**OPTIONAL**  
PRI85 - 400 W  
VBR4781 - VBR4782 - VBR4783 - VBR4786

Piano intermedio riscaldato  
Heated intermediate shelf  
Étagère intermédiaire chauffée  
Beheiztes Zwischenfach

180 €

	VBR 4751	VBR 4781	VBR 4752	VBR 4782	VBR 4753	VBR 4783
	250 W	400 W	250 W	400 W	400 W	
	230V/ 50-60 HZ					
	+30° +90°C					
	1		2		3	
	50 x 35 x 25(h) cm	85 x 35 x 25(h) cm	50 x 35 x 40(h) cm	85 x 35 x 40(h) cm	50 x 35 x 54(h) cm	85 x 35 x 54(h) cm
	320 €	400 €	430 €	530 €	520 €	660 €

 Vettrine riscaldanti  
Heated display cases

**+5%**

**forcar**

## VBR 4756 - VBR 4786









VBR 4786

IT Vetrine riscaldate. Struttura in acciaio inox **AISI 304** - fianchi e antine sui due fronti in plexiglass trasparente - termostato regolabile - dispositivo di umidificazione.

EN Heated display cases. Structure in stainless steel **AISI 304** - Plexiglas sides and doors on both sides - adjustable thermostat - humidification device.

FR Vitrines chauffées. Structure en acier inox **AISI 304** - côtés et portes des deux côtés en plexiglass transparent - thermostat réglable - dispositif d'humidification.

DE Beheizte Vitrinen. Struktur aus Edelstahl **AISI 304** - Seiten und Türen auf beiden Seiten aus transparentem Plexiglas - einstellbarer Thermostat - Befeuchtungsvorrichtung.

	VBR 4756	VBR 4786
	250 W	400 W
 1 Ph	230V/ 50-60 HZ	
	+30° +90°C	
 N.	2	
	50 x 35 x 40(h) cm	85 x 35 x 40(h) cm
	430 €	540 €

Vetrine riscaldanti  
Heated display cases

+5%

## VBN 4756 - VBN 4786





VBN 4756

IT Vetrine neutre. Struttura in acciaio inox **AISI 304** - fianchi e antine sui due fronti in plexiglass trasparente - dispositivo di umidificazione.

EN Neutral display cases. Structure in stainless steel **AISI 304** - clear Plexiglas sides and doors on both sides - humidification device.

FR Vitrines neutres. Structure en acier inox **AISI 304** - côtés et portes des deux côtés en plexiglass transparent - dispositif d'humidification.

DE Neutrale Vitrinen. Struktur aus Edelstahl **AISI 304** - Seiten und Türen auf beiden Seiten aus transparentem Plexiglas - Befeuchtungsvorrichtung.

	VBN 4756	VBN 4786
 N.	2	
	50 x 35 x 40(h) cm	85 x 35 x 40(h) cm
	300 €	390 €

Vetrine neutre  
Neutral display

+5%

VBN 4751 - VBN 4781  
 VBN 4752 - VBN 4782  
 VBN 4753 - VBN 4783



VBN 4751

IT Vetrine neutre. Struttura in acciaio inox **AISI 304** - fianchi e antine sui due fronti in plexiglass trasparente - dispositivo di umidificazione.

EN Neutral display cases. Structure in stainless steel **AISI 304** - clear Plexiglas sides and doors on both sides - humidification device.

FR Vitrines neutres. Structure en acier inox **AISI 304** - côtés et portes des deux côtés en plexiglas transparent - dispositif d'humidification.

DE Neutrale Vitrinen. Struktur aus Edelstahl **AISI 304** - Seiten und Türen auf beiden Seiten aus transparentem Plexiglas - Befeuchtungsvorrichtung.

VBE 50



VBE 85



IT Vetrina porta brioches e croissant. Struttura unica completamente in plexiglass con antine apribili sui due lati.

EN Brioche and croissants display case. Single structure completely in Plexiglas with openable doors on both sides.

FR Vitrine pour brioches et croissants. Structure unique entièrement en plexiglas avec portes qui peuvent être ouvertes des deux côtés.

DE Vitrine für Croissants und Hörnchen. Struktur komplett aus Plexiglas mit zweiseitig aufklappbaren Türen.

	VBE 50	VBE 85
	1	
	50 x 35 x 18(h) cm	85 x 35 x 18(h) cm
	150 €	200 €



	VBN 4751	VBN 4781	VBN 4752	VBN 4782	VBN 4753	VBN 4783
	1		2		3	
	50 x 35 x 25(h) cm	85 x 35 x 25(h) cm	50 x 35 x 36(h) cm	85 x 35 x 36(h) cm	50 x 35 x 50(h) cm	85 x 35 x 50(h) cm
	190 €	240 €	290 €	380 €	380 €	490 €

 Vetrine neutre  
Neutral display

+5%

forcar®

VL 4748  
VL 4749

 NOCE/WALNUT
  WENGÉ
  BIANCO/WHITE



VL 4748W



VL 4749



VL 4748B

IT Vetrina porta brioches e croissant. Piano in legno - disponibile nei colori noce, wengé e bianco. Cupola in plexiglass semitrasparente con antine apribili sui 2 lati.

EN Brioches and croissants display case. Wooden top - available in walnut, wengé and white colour. Semi-transparent Plexiglas dome with openable doors on 2 sides.

FR Vitrine pour brioches et croissants. Plan en bois - disponible en noyer, wengé et blanc. Clochette en plexiglas semi-transparent avec portes qui peuvent être ouvertes des deux côtés.

DE Vitrine für Croissants und Hörnchen. Holzplatte - erhältlich in Nussbaum, Wenge und Weiß. Haltransparente Plexiglashaube zweiseitig aufklappbare Türen.

	VL 4748 noce/walnut	VL 4748W wengé	VL 4748B bianco/white	VL 4749 noce/walnut	VL 4749W wengé	VL 4749B bianco/white
	1					
	50 x 35 x 21(h) cm			85 x 35 x 21(h) cm		
	165 €		180 €	195 €		210 €

Vetrine neutre  
Neutral display

**+5%**

# VPH 100 - VPH 120 VPH 160









VPH 100

IT Vetrine riscaldate con griglie - doppio vetro - struttura in acciaio inox **AISI 304** - fianchi e antine sui due fronti in plexiglass trasparente - termostato regolabile.

EN Heated display cases, with grids - double-glazed - structure in stainless steel **AISI 304** - clear Plexiglas sides and doors on both sides - adjustable thermostat.

FR Vitrines chauffées, avec grilles - double vitrage - structure en acier inox **AISI 304** - côtés et portes des deux faces en plexiglas transparent - thermostat réglable.

DE Beheizte Vitrinen, mit Gitter - Doppelglas - Struktur aus Edelstahl **AISI 304** - Seiten und Türen auf beiden Seiten aus transparentem Plexiglas - einstellbarer Thermostat.

	VPH 100	VPH 120	VPH 160
	1100 W		
 1 Ph	230V/ 50-60 HZ		
	+30° +90°C		
 N.	2 piani - 2 griglie 2 shelves - 2 grids		
	71 x 46 x 67(h) cm	71 x 58 x 67(h) cm	88 x 58 x 67(h) cm
	640 €	760 €	920 €

+5%

# MS 1860 MS 1862 MS 1866









MS 1862

IT Mobiletto scaldapiatti. Struttura in acciaio inox **AISI 304** - termostato regolabile - 1 ripiano intermedio coibentato - ruote multidirezionali ø 95 mm.

EN Plate warmer cabinet. **AISI 304** stainless steel structure - adjustable thermostat - 1 insulated intermediate shelf - multidirectional wheels ø 95 mm.

FR Armoire chauffe-plat. Structure en acier inox **AISI 304** - thermostat réglable - 1 étagère intermédiaire isolée - roues multidirectionnelles de ø 95 mm.

DE Tellerwärmer Schrank. Struktur aus Edelstahl **AISI 304** - einstellbarer Thermostat - 1 isolierte Zwischenablage - Mehrwegräder ø 95 mm.

	MS 1860	MS 1862	MS 1866
	800 W		
 1 Ph	230V/ 50-60 HZ		
	+30° +90°C		
	60 piatti / plates <b>1 porta / door</b>	100 piatti / plates <b>2 porte / doors</b>	120 piatti / plates <b>2 porte / doors</b>
	39 x 42 x 95(h) cm	70 x 42 x 80(h) cm	70 x 42 x 95(h) cm
	700 €	880 €	950 €

## RTR 97L



## RTR 97L2



## RTR 137L









IT Vetrine riscaldate, da banco con griglie - doppio vetro - struttura in acciaio inox **AISI 304** - fianchi e antine sui due fronti in plexiglass trasparente - termostato regolabile.

EN Heated display cases, counter-top versions with grids - double-glazed - structure in stainless steel **AISI 304** - clear Plexiglas sides and doors on both sides - adjustable thermostat.

FR Vitrines chauffées, de table avec grilles - double vitrage - structure en acier inox **AISI 304** - côtés et portes des deux faces en plexiglas transparent - thermostat réglable.

DE Beheizte Vitrinen, Tischmodell mit Gitter - Doppelglas - Struktur aus Edelstahl **AISI 304** - Seiten und Türen auf beiden Seiten aus transparentem Plexiglas - einstellbarer Thermostat.

	RTR 97L	RTR 97L2	RTR 137L
			
	400 W		
 1 Ph	230V/ 50-60 HZ		
	+30° +90°C		
 N.	3 piani / shelves	3 piani tondi rotanti 3 rotating round shelves	3 piani / shelves
 cm	46 x 45 x 78,5(h) cm		64,5 x 45 x 78,5(h) cm
	660 €	740 €	760 €

Vetrine riscaldanti con griglie  
Heated display cases with grids

**+5%**



# Carrelli per la cucina

KITCHEN TROLLEYS  
CHARIOTS POUR LA CUISINE  
KÜCHENWAGEN



## CA 1450



## CA 1460



## CA 1470



**IT** Carrelli portavassoi. Struttura e guide in acciaio inox - paracolpi in gomma - ruote multidirezionali  $\varnothing$  125 mm. Predisposti di serie per vassoi GN1/1 - 53x32,5 cm. Realizzabili su richiesta per qualsiasi misura di vassoio, da specificare al momento dell'ordine.

**EN** Tray trolleys - Stainless steel structure and slides - rubber shock absorbers - multidirectional wheels  $\varnothing$  125 mm. Standard equipped for GN1/1 trays - 53x32,5 cm. Available on request for any tray size, to be mentioned when ordering.

**FR** Chariots porte plateaux. Structure et guides en acier inox - butoirs en caoutchouc - roues multidirectionnelles  $\varnothing$  125 mm. Prêt en standard pour plateaux GN1/1 - 53x32,5 cm. Disponible sur demande pour toute taille de plateau, à préciser à la commande.

**DE** Tablettwagen - GN1/1. Struktur und Führungen aus Edelstahl - Gummistoßschutz - Mehrwegräder  $\varnothing$  125 mm. Standardmäßig vorgesehen für Bleche GN1/1 - 53x32,5 cm. Erhältlich auf Anfrage für jede Blechgröße, bitte bei der Bestellung angeben.

	CA 1450	CA 1460	CA 1470
 cm	38 x 62 x 175(h) cm	74 x 62 x 175(h) cm	110 x 62 x 175(h) cm
 N.	10 vassoi / trays	20 vassoi / trays	30 vassoi / trays
	310 €	470 €	630 €

Carrelli portavassoi GN1/1  
GN1/1 tray trolleys

**+5%**

OPTIONAL



# CA 1450P

# CA 1460P

# CA 1470P



h 12 cm



h 12 cm



h 12 cm

PANNELLI  
LATERALI  
SIDE  
PANELS



BIANCO/WHITE



INOX

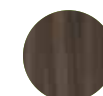

WENGÉ

IT Carrelli portavassoi con pannelli laterali in perfix bianco, acciaio inox o wengé. Struttura e guide in acciaio inox - paracolpi in gomma - ruote multidirezionali  $\varnothing$  125 mm. Predisposti di serie per vassoi GN1/1 - 53x32,5 cm. Realizzabili su richiesta per qualsiasi misura di vassoio e/o con pannello posteriore, da specificare al momento dell'ordine.

FR Chariots porte plateaux à panneaux latéraux en perfix blanc, acier inox ou wengé. Structure et guides en acier inox - butoirs en caoutchouc - roues multidirectionnelles  $\varnothing$  125 mm. Prêt en standard pour plateaux GN1/1 - 53x32,5 cm. Disponible sur demande pour toute taille de plateau et / ou avec panneau arrière, à préciser à la commande.

EN Tray trolleys with side panels in white perfix, stainless steel or wengé. Stainless steel structure and slides - rubber shock absorbers - multidirectional wheels  $\varnothing$  125 mm. Standard equipped for GN1/1 trays - 53x32,5 cm. Available on request for any tray size and/or with rear panel, to be mentioned when ordering.

DE Tablettwagen mit Seitenwänden in Weiß Perfix, Edelstahl oder Wenge. Struktur und Führungen aus Edelstahl - Gummistoßschutz - Mehrwegräder  $\varnothing$  125 mm. Standardmäßig vorgesehen für Bleche GN1/1 - 53x32,5 cm. Erhältlich auf Anfrage für jede Blechgröße und / oder mit Rückwand, bitte bei der Bestellung angeben.

	CA1450P bianco-white	CA1450PI inox	CA1450PW wengé	CA1460P bianco-white	CA1460PI inox	CA1460PW wengé	CA1470P bianco-white	CA1470PI inox	CA1470PW wengé
	38 x 62 x 175(h) cm			74 x 62 x 175(h) cm			110 x 62 x 175(h) cm		
	10 vassoi / trays			20 vassoi / trays			30 vassoi / trays		
	360 €	430 €	400 €	510 €	590 €	550 €	690 €	740 €	740 €

98 Carrelli portavassoi con pannelli laterali GN1/1  
GN1/1 Tray trolleys with side panels

+5%

forcar®

# CA 1451R

# CA 1461R

# CA 1471R



PANNELLI  
LATERALI  
SIDE  
PANELS



**IT** Carrelli portavassoi rinforzati, disponibili anche con pannelli laterali in perfix bianco o in acciaio inox. Struttura tubolare in acciaio inox 25x25 cm - guide in acciaio inox di spessore 1,2 mm - paracolpi in gomma - ruote multidirezionali  $\varnothing$  125 mm. Predisposti di serie per vassoi GN1/1 - 53x32,5 cm. Realizzabili su richiesta per qualsiasi misura di vassoio e/o con pannello posteriore, da specificare al momento dell'ordine.

**EN** Reinforced tray trolleys also available with side panels in white perfix or stainless steel. Stainless steel tubular structure 25x25 mm - stainless steel slides with 1,2 mm thickness - rubber shock absorbers - multidirectional wheels  $\varnothing$  125 mm. Standard equipped for GN1/1 trays - 53x32,5 cm. Available on request for any tray size and/or with rear panel, to be mentioned when ordering.

**FR** Chariots à plateaux renforcés disponibles aussi avec panneaux latéraux en perfix blanc ou acier inox. Structure tubulaire en acier inox 25x25 cm - guides en acier inox épaisseur 1,2 mm - butoir en caoutchouc - roues multidirectionnelles  $\varnothing$  125 mm. Prêt en standard pour plateaux GN1/1 - 53x32,5 cm. Disponible sur demande pour toute taille de plateau et / ou avec panneau arrière, à préciser à la commande.

**DE** Verstärkte Tablettwagen auch mit Seitenwänden aus weißem Perfix oder Edelstahl erhältlich. Struktur aus Edelstahl 25x25 mm - 1,2 mm dicke Edelstahlführungen - Gummistoßschutz - Mehrwegräder  $\varnothing$  125 mm. Standardmäßig vorgesehen für Bleche GN1/1 - 53x32,5 cm. Erhältlich auf Anfrage für jede Blechgröße und / oder mit Rückwand, bitte bei der Bestellung angeben.

	CA1451R	CA1451RP bianco-white	CA1451RPI inox	CA1461R	CA1461RP bianco-white	CA1461RPI inox	CA1471R	CA1471RP bianco-white	CA1471RPI inox
	38 x 62 x 175(h) cm			74 x 62 x 175(h) cm			110 x 62 x 175(h) cm		
	10 vassoi / trays			20 vassoi / trays			30 vassoi / 30 trays		
	370 €	420 €	470 €	585 €	640 €	685 €	785 €	860 €	860 €

Carrelli portavassoi rinforzati GN1/1  
GN1/1 tray trolleys - reinforced

**+5%**

OPTIONAL



# CA 1455

# CA 1465

# CA 1475



PANNELLI  
LATERALI  
SIDE  
PANELS



IT Carrelli portavassoi universali con possibilità di avere pannelli laterali in perfix bianco o in acciaio inox. Struttura in acciaio inox - guide in filo di acciaio cromato - paracolpi in gomma - ruote multidirezionali ø 125 mm. Bacinelle e teglie escluse.

FR Chariots à plateaux universels isponibles aussi avec panneaux latéraux en perfix blanc ou acier inox. Structure en acier inox - glissières en fil d'acier chromé - butoirs en caoutchouc - roues multidirectionnelles ø 125 mm. Bacs et plaques pas compris.

EN Universal tray trolleys also available with side panels in white perfix or stainless steel. Stainless steel structure - chromed steel wire slides - rubber shock absorbers - multidirectional wheels ø 125 mm. Containers and pans not included.

DE Universal-Tablett Wagen auch mit Seitenwänden aus weißem Perfix oder Edelstahl erhältlich. Struktur aus Edelstahl - verchromte Stahldrahtführungen - Gummistoßschutz - Mehrwegräder ø 125 mm. Behältern und Bleche nicht enthalten.

	CA 1455	CA 1455P bianco-white	CA 1455PI inox	CA1465	CA1465P bianco-white	CA1465PI inox	CA1475	CA1475P bianco-white	CA1475PI inox
	52 x 62 x 175(h) cm			95 x 62 x 175(h) cm			138 x 62 x 175(h) cm		
	10 vassoi / trays			20 vassoi / trays			30 vassoi / trays		
	290 €	350 €	420 €	440 €	490 €	550 €	570 €	635 €	700 €

 Carrelli portavassoi universali  
Universal tray trolleys

**+5%**

**forcar**

## CA 1455V12

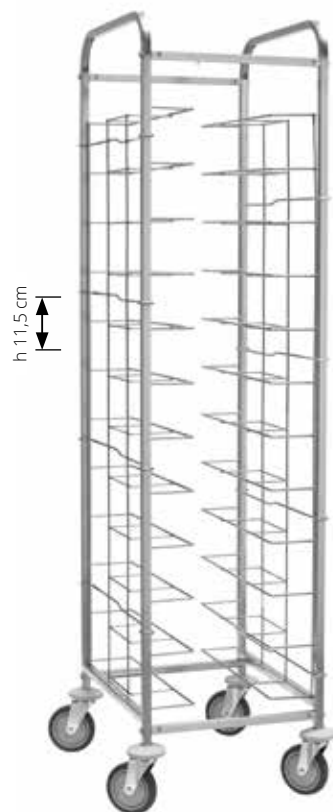

## PT 15

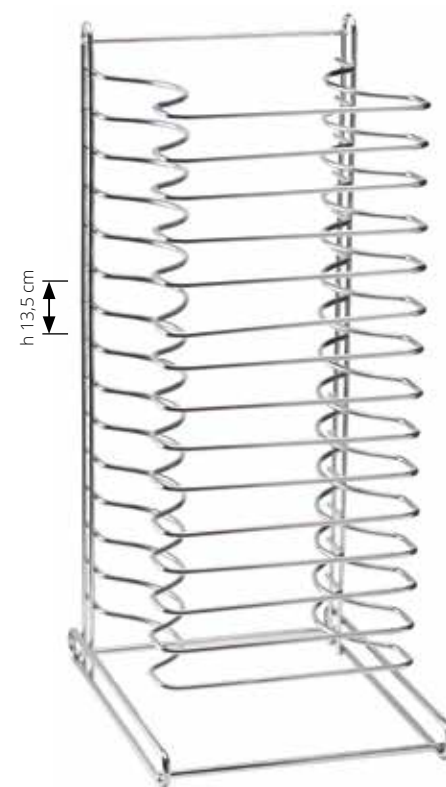

IT Carrelli portavassoi universali con possibilità di avere pannelli laterali in perfix bianco o in acciaio inox. Struttura in acciaio inox - guide in filo di acciaio cromato - paracolpi in gomma - ruote multidirezionali  $\varnothing$  125 mm. Vassoi in foto esclusi.

EN Universal tray trolleys. Stainless steel structure - chromed steel wire slides - rubber shock absorbers - multidirectional wheels  $\varnothing$  125 mm. Containers and pans not included.

FR Chariots à plateaux universels. Structure en acier inox - glissières en fil d'acier chromé - butoirs en caoutchouc - roues multidirectionnelles  $\varnothing$  125 mm. Bacs et plaques pas compris.

DE Universal-Tablett Wagen. Struktur aus Edelstahl - verchromte Stahldrahtführungen - Gummistoßschutz - Mehrwegräder  $\varnothing$  125 mm. Behältern und Bleche nicht enthalten.



IT Portateglie da banco per teglie tonde da cm. 26 a 32. Confezione minima 4 pz.

EN Table-top tray holder for round trays size 26 to 32 cm. Minimum pack 4 pcs.

FR Porte-plateau de table pour plateaux ronds de 26 à 32 cm. Paquet minimum de 4 pièces.

DE Tisch-Tabletthalterung für runde Tablette von 26 bis 32 cm. Mindestmenge 4 Stück.

	CA 1455V12
	58 x 52 x 185(h) cm
	12 vassoi / trays
	340 €

	PT 15
	38 x 29 x 67(h) cm
	15 teglie / trays
	70 €

+5%

Carrelli portavassoi universali  
Universal tray trolleys

CA 1476

CA 1477

CA 1478

CA 1479



IT Carrelli portateglie GN. Struttura e guide in acciaio inox - paracolpi in gomma - ruote multidirezionali  $\varnothing$  125 mm. Predisposti di serie per GN2/1. A richiesta possibilità di altre misure. Teglie escluse.

EN GN pans trolleys Stainless steel structure and slides - rubber shock absorbers - multidirectional wheels  $\varnothing$  125 mm. Standard equipped for GN2/1. Other sizes available on request. Trays not included.

FR Chariots à plateaux GN. Structure et glissières en acier inox - butoirs en caoutchouc - roues multidirectionnelles  $\varnothing$  125 mm. En standard pour GN2/1. Autres mesures disponibles sur demande. Plateaux pas compris.

DE GN-Blechwagen. Struktur und Führungen aus Edelstahl - Gummistoßschutz - Mehrwegräder  $\varnothing$  125 mm. Serienmäßig ausgerüstet für GN2/1. Andere Größen sind auf Anfrage erhältlich. Bleche nicht enthalten.

	CA 1476	CA 1477	CA 1478	CA 1479
	65 x 76 x 182(h) cm	65 x 76 x 94(h) cm	45 x 66 x 94(h) cm	45 x 66 x 182(h) cm
	14 x GN2/1 - 28 x GN1/1	8 x GN2/1 - 16 x GN1/1	8 x GN1/1	14 x GN1/1
	420 €	410 €	370 €	390 €

102 Carrelli portateglie GN1/1 - GN2/1  
GN1/1 - GN2/1 pans trolleys

+5%

forcar®

# CA 1489R

# CA 1486R

# CA 1492R



AV4947 60 x 30 x 2(h) cm	AV4937 60 x 40 x 2(h) cm
Teglia Blurex - Blurex tray Plaque Blurex - Blurex Form	
	
18 €	
AV4950 60 x 30 x 2(h) cm	AV4940 60 x 40 x 2(h) cm
Teglia alluminata - Aluminized pan Pan aluminisé - Aluminisierte pan	
	
18 €	
AV4980 60 x 40 x 2(h) cm	
Teglia in alluminio - Aluminium tray Plateau en aluminium Aluminiumschale	
	
20 €	

IT Carrelli portateglie GN rinforzati. Struttura tubolare in acciaio inox 25x25 cm - guide in acciaio inox di spessore 1,2 mm - paracolpi in gomma - ruote multidirezionali ø 125 mm. Teglie escluse.

FR Chariots à plateaux GN renforcés. Structure tubulaire en acier inox 25x25 cm - glissières en acier inox épaisseur 1,2 mm - butoir en caoutchouc - roues multidirectionnelles ø 125 mm. Plateaux pas compris.

EN GN pans trolleys - reinforced Stainless steel tubular structure 25x25 mm - stainless steel slides with 1,2 mm thickness - rubber shock absorbers - multidirectional wheels ø 125 mm. Trays not included.

DE Verstärkte GN-Blechwagen. Edelstahlrohrstruktur 25x25 cm - 1,2 mm dicke Edelstahlführungen - Gummistoßschutz - Mehrwegräder ø 125 mm. Bleche nicht enthalten.

	CA 1489R	CA 1486R	CA 1492R
	48 x 62 x 182(h) cm	66 x 72 x 182(h) cm	53 x 72 x 182(h) cm
	14 x GN1/1	14 x GN2/1 - 28 x GN1/1	teglie / trays 60 x 40 cm
	550 €	590 €	500 €

+5%

Carrelli portateglie rinforzati GN1/1 - GN2/1 - 60x40 cm  
GN1/1 - GN2/1 - 60x40 cm pans trolleys - reinforced

OPTIONAL



# CA 1650 - CA 1655 CA 1656



CA 1656

CA 1650

# CA 1482 - CA 1482 T20 CA 1483 - CA 1493



CA 1482

CA 1483

IT Carrelli portateglie 60x40 cm e porta bacinelle GN1/1 65(h) mm. Struttura in acciaio inox - guide in filo di acciaio cromato - paracolpi in gomma - ruote multidirezionali  $\varnothing$  125 mm. Bacinelle e teglie escluse.

EN Tray trolleys 60x40 cm and trays GN1/165(h) mm. Stainless steel structure - chromed steel wire slides - rubber shock absorbers - multidirectional wheels  $\varnothing$  125 mm. Containers and pans not included.

FR Chariots à plateaux 60x40 cm et pour bacs GN1/1 65(h) mm. Structure en acier inox - glissières en fil d'acier chromé - butoirs en caoutchouc - roues multidirectionnelles  $\varnothing$  125 mm. Bacs et plaques pas compris.

DE Tablett Wagen 60x40 cm und Tablett GN1/1 65(h) mm. Struktur aus Edelstahl - verchromte Stahldrahtführungen - Gummistoßschutz - Mehrwegräder  $\varnothing$  125 mm. Behältern und Bleche nicht enthalten.

IT Carrelli portateglie per pasticceria. Struttura e guide in acciaio inox - paracolpi in gomma - ruote multidirezionali  $\varnothing$  125 mm. A richiesta altre misure disponibili. Teglie escluse.

EN Pastry tray trolleys Stainless steel structure and slides - rubber shock absorbers - multidirectional wheels  $\varnothing$  125 mm. Other sizes available on request. Trays not included.

FR Chariots à plateaux pâtisserie. Structure et glissières en acier inox - butoirs en caoutchouc - roues multidirectionnelles  $\varnothing$  125 mm. Autres mesures disponibles sur demande. Plateaux pas compris.

DE Konditorei-Blechwagen. Struktur und Führungen aus Edelstahl - Gummistoßschutz - Mehrwegräder  $\varnothing$  125 mm. Andere Größen sind auf Anfrage erhältlich. Bleche nicht enthalten.

	CA 1655	CA 1656	CA 1650
	77 x 46 x 118(h) cm	77 x 46 x 155(h) cm	68 x 52 x 175(h) cm
	GN1/1 65(h) mm 10 teglie / trays 60x40 cm	GN1/1 65(h) mm 15 teglie / trays 60x40 cm	GN1/1 65(h) mm 10 teglie/trays - 60x40 cm e vassoi / trays
	320 €	370 €	400 €

	CA 1482	CA 1482 T20	CA 1483	CA 1493
	52 x 72 x 182(h) cm		52 x 72 x 94(h) cm	85 x 65 x 94(h) cm
	14 teglie / trays 60 x 40 cm	20 teglie / trays 60 x 40 cm	8 teglie / trays 60 x 40 cm	8 teglie / trays 80 x 60 cm 16 teglie / trays 60 x 40 cm
	400 €	490 €	400 €	455 €

 Carrelli portateglie per pasticceria  
Pastry tray trolleys

+5%

forcar®



## CA 1480



## CA 1480D

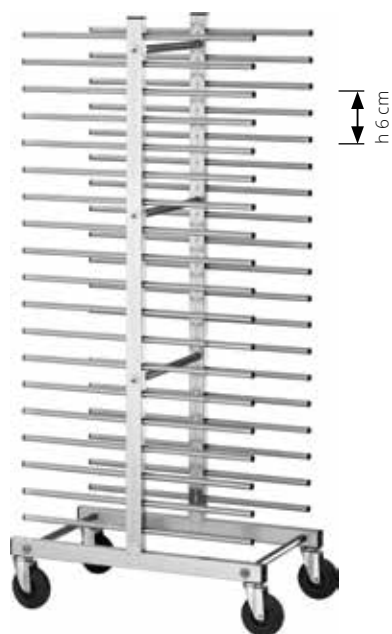

IT Carrelli portateglie universali. Struttura e guide in acciaio inox - paracolpi in gomma - ruote multidirezionali  $\varnothing$  125 mm. Teglie escluse

EN Universal tray trolleys. Stainless steel structure and slides - rubber shock absorbers - multidirectional wheels  $\varnothing$  125 mm. Trays not included.

FR Chariots à plateaux universels. Structure et glissières en acier inox - butoirs en caoutchouc - roues multidirectionnelles  $\varnothing$  125 mm. Plateaux pas compris.

DE Universal-Blechwagen. Struktur und Führungen aus Edelstahl - Gummistoßschutz - Mehrwegräder  $\varnothing$  125 mm. Bleche nicht enthalten.

	CA 1480	CA 1480D
		
	51 x 47 x 177(h) cm	51 x 80 x 177(h) cm
	20 teglie / trays	40 teglie / trays
	400 €	500 €

+5%

Carrelli portateglie per pasticceria rinforzati  
Reinforced pastry tray trolleys

## Optional

A510	A500
Bacinella portabottiglie in ABS ABS bottle tray Porte-bouteilles en ABS ABS Flaschenhalter	Bacinella portabottiglie in acciaio inox Stainless steel bottle tray Porte-bouteilles en acier inox Edelstahl Flaschenhalter
35 €	80 €



A 512
Ruote con freno - Wheels with catch Roues avec frein - Räder mit Bremse
CA1450-CA1455-CA1460-CA1470-CA1465-CA1475-CA1477-CA1476- CA1478-CA1479-CA1480-CA1480D-CA1482-CA1482T20-CA1483-CA1493
8 € cad./each

A 514
Ruote con freno - Wheels with catch Roues avec frein - Räder mit Bremse
CA1451-CA1461-CA1471-CA1489R-CA1486R-CA1492
10 € cad./each



A 512

A 514



# Carrelli portapiatti e cestelli

PLATE AND BASKETS TROLLEYS  
PORTE-ASSIETTES ET PANIERS  
TELLER- UND KORBWAGEN

CA 1435  
CA 1436  
CA 1435G  
CA 1436G



CA 1435



GRIGLIA  
VERNICIATA  
PAINTED  
GRID



WARNING

Dimensioni imballo  
Packing dimensions  
35 x 90 x 50(h) cm



GRIGLIA  
CROMATA  
CHROME  
PLATED GRID

CA 1437  
CA 1438  
CA 1437G  
CA 1438G

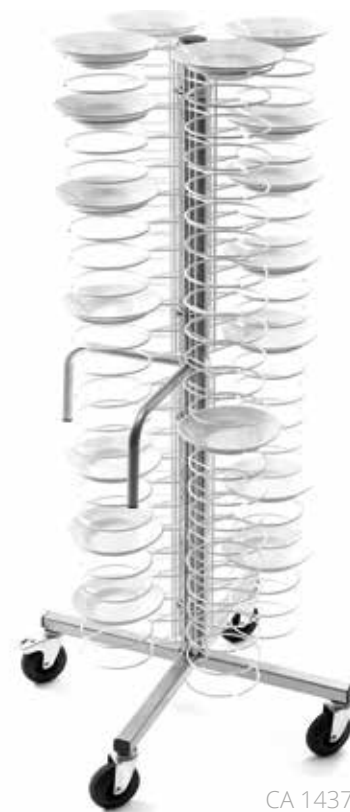

CA 1437



GRIGLIA  
VERNICIATA  
PAINTED  
GRID



WARNING

Dimensioni imballo  
Packing dimensions  
35 x 165 x 50(h) cm



GRIGLIA  
CROMATA  
CHROME  
PLATED GRID

IT Colonna portapiatti da banco. Struttura in acciaio - griglie verniciate o cromate - piedini regolabili.

EN Countertop tiered plate holder stand. Steel frame - painted or chromed grids - adjustable feet.

FR Colonne porte-assiettes de table. Structure en acier - grilles peintes ou chromées - pieds réglables.



DE Tellerwagen, Tischmodell. Stahlstruktur - lackierte oder verchromte Gitter - verstellbare FüÙe.



IT Carrelli portapiatti. Struttura in acciaio plastificato - griglie verniciate o cromate - maniglie per conduzione carrello - ruote ø 125 mm di cui due con freno.

EN Plate trolleys. Plastic-coated steel structure - painted or chrome-plated grids - handles for trolley operation - ø 125 mm wheels, two of which with brakes.

FR Chariots à assiettes. Structure en acier plastifié - grilles peintes ou chromées - poignées pour l'entraînement du chariot - roues de ø 125 mm, dont deux avec freins.

DE Tellerwagen. Struktur aus kunststoffbeschichtetem Stahl - lackierte oder verchromte Gitter - Lenkergriff - Räder ø 125 mm, davon zwei mit Bremsen.

	CA 1435 griglie verniciate painted grid	CA 1436 griglie cromate chrome-plated grill	CA 1435G griglie verniciate painted grid	CA 1436G griglie cromate chrome-plated grill
	60 x 60 x 83(h) cm		70 x 70 x 83(h) cm	
	48 piatti / plates ø 18/23 cm		48 piatti / plates ø 25/31 cm	
	310 €	315 €	330 €	330 €

	CA 1437 griglie verniciate painted grid	CA 1438 griglie cromate chrome-plated grill	CA 1437G griglie verniciate painted grid	CA 1438G griglie cromate chrome-plated grill
	60 x 60 x 173(h) cm		70 x 70 x 173(h) cm	
	96 piatti / plates ø 18/23 cm		96 piatti / plates ø 25/31 cm	
	520 €	530 €	545 €	555 €

Portapiatti da banco  
Table top plate rack

+5%



Confezionamento in kit per risparmio costi trasporto  
Packing in set for saving transport charges  
Emballage en kit pour sauver frais d'expédition  
Verpackung in kit um Versandkosten zu sparen

# CA 1439P



WARNING

Dimensioni imballo  
Packing dimensions  
40 x 165 x 68(h) cm  
peso / weight 50 kg

Confezionamento in kit per risparmio costi trasporto  
Packing in set for saving transport charges  
Emballage en kit pour sauver frais d'expédition  
Verpackung in kit um Versandkosten zu sparen



# CA 1439 CA 1440 CA 1439G CA 1440G



GRIGLIA  
VERNICIATA  
PAINTED  
GRID



WARNING



GRIGLIA  
CROMATA  
CHROME  
PLATED GRID

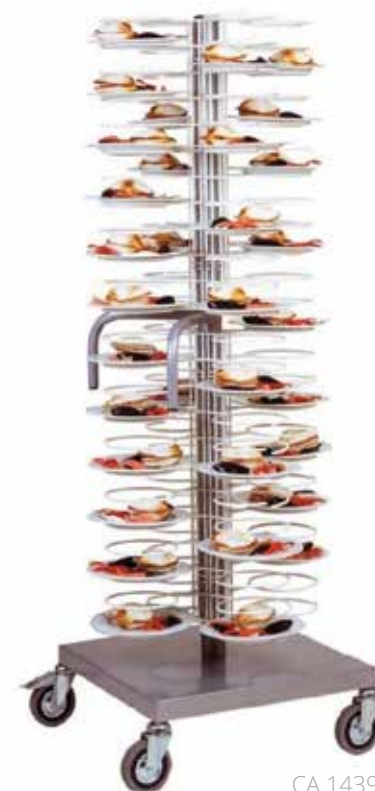

CA 1439

- IT Portapiatti da parete. Struttura in acciaio plastificato - griglie plastificate o cromate.
- EN Wall plate holder. Plastic-coated steel structure - plastic-coated or chrome-plated grids.
- FR Porte-assiettes à mur. Structure en acier plastifié - grilles plastifiées ou chromées.
- DE Wandtellerhalter. Kunststoffbeschichtete Stahlstruktur - beschichtete oder verchromte Gitter.

- IT Carrelli portapiatti. Struttura in acciaio plastificato con base in lamiera antipolvere - griglie verniciate o cromate - maniglie per conduzione carrello - ruote ø 125 mm di cui due con freno.
- EN Plate trolleys. Plastic-coated steel structure with dust-proof lower shelf - painted or chrome-plated grids - handles for trolley operation - ø 125 mm wheels, two of which with brakes.
- FR Chariots à assiettes. Structure en acier plastifié avec base en tôle anti-poussière - grilles peintes ou chromées - poignées pour l'entraînement du chariot - roues de ø 125 mm, dont deux avec freins.
- DE Tellerwagen. Struktur aus kunststoffbeschichtetem Stahl mit staubdichtem Boden - lackierte oder verchromte Gitter - Lenkergriff - Räder ø 125 mm, davon zwei mit Bremsen.

	CA 1439P
	42 x 20 x 90(h) cm
	12 piatti / plates ø 18/23 cm
	80 €

+5%

	CA 1439 griglie verniciate painted grid	CA 1440 griglie cromate chrome-plated grill	CA1439G griglie verniciate painted grid	CA1440G griglie cromate chrome-plated grill
	60 x 60 x 175(h) cm		70 x 70 x 175(h) cm	
	96 piatti / plates ø 18/23 cm		96 piatti / plates ø 25/31 cm	
	600 €	615 €	625 €	640 €

Carrelli portapiatti  
Plate trolley

forcar®

108 Portapiatti da parete  
Wall plate rack

## Optional

A 410 (mod.CA 1439-1440)	A 420 (mod.CA 1439G-1440G)
Copertura in PVC con 4 cerniere. PVC lid with 4 hinges. Couverture en PVC avec 4 charnières. PVC-Abdeckung mit 4 Scharnieren.	
250 €	300 €

A 512 (mod.CP 1441-1441C - CA 631-656-659)
Ruote con freno Wheels with catch Roues avec frein Räder mit Bremse
8 € cad./each

A 1001 (mod.CP 1441-1441C)	A 1002 (mod.CP 1441-1441C)
Cestino piccolo Small basket Petit panier Klein Korb	Cestino grande Big basket Grand panier Gros Korb
10 €	25 €



+5%

## CP 1441 - CP 1441C



CP 1441

CP 1441C

IT Carrelli per il trasporto piatti. Struttura in tubo di acciaio inox - ripiano portapiatti e pannellatura in lamiera di acciaio inox - ruote multidirezionali ø 125 mm.

EN Dish transport trolleys. Structure in stainless steel tube - stainless steel plate shelf and panelling - multidirectional wheels ø 125 mm.

FR Chariots pour transporter la vaisselle. Structure en tube d'acier inox - étagère et revêtement en tôle d'acier inox - roues multidirectionnelles ø 125 mm.

DE Geschirrwagen. Edelstahlrohrstruktur - Tellerablage und Verkleidung aus Edelstahlblech - Mehrwegräder ø 125 mm.

i	CP 1441	CP 1441C
↗ cm	91 x 57 x 101(h) cm	
N. 	1	2
	200 piatti / plates	
	375 €	460 €

+5%

## CG 1439A



GRIGLIA  
VERNICIATA  
PAINTED  
GRID



IT Carrelli portapiatti armati. Struttura portante in acciaio plastificato - telaio in alluminio anodizzato - pannellatura in perflex con 4 sportelli apribili in plexiglas - griglie verniciate o cromate - maniglie laterali per conduzione carrello - ruote multidirezionali ø 125 mm di cui due con freno.

EN Cabinet plate trolleys. Supporting structure in plastic-coated steel - anodized aluminium frame - perflex panelling with 4 openable Plexiglas doors - painted or chrome-plated grids - side handles for trolley operation - multidirectional wheels ø 125 mm, two of which with brakes.

FR Chariots porte-assiettes sur élément fermé. Structure portante en acier plastifié - corps en aluminium anodisé - panneaux en perflex avec 4 portes ouvrantes en plexiglas - grilles peintes ou chromées - poignées latérales pour le déplacement - roues multidirectionnelles ø 125 mm dont deux avec frein.

DE Tellerwagen mit Schrankelement. Tragstruktur aus kunststoffbeschichtetem Stahl - Rahmen aus eloxiertem Aluminium - Blenden in Perflex mit 4 Flügeltüren aus Plexiglas - lackierte oder verchromte Gitter - seitliche Lenkergriffe - Mehrwegräder ø 125 mm, zwei davon mit Bremsen.

	CG 1439A griglie verniciate / painted grid
	75 x 78 x 170(h) cm
	10 griglie verniciate GN2/1 - 10 painted grids GN2/1
	1580 €

## CA 1439A CA 1440A CA 1439AG CA 1440AG

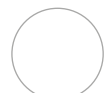

GRIGLIA  
VERNICIATA  
PAINTED  
GRID



GRIGLIA  
CROMATA  
CHROME  
PLATED GRID

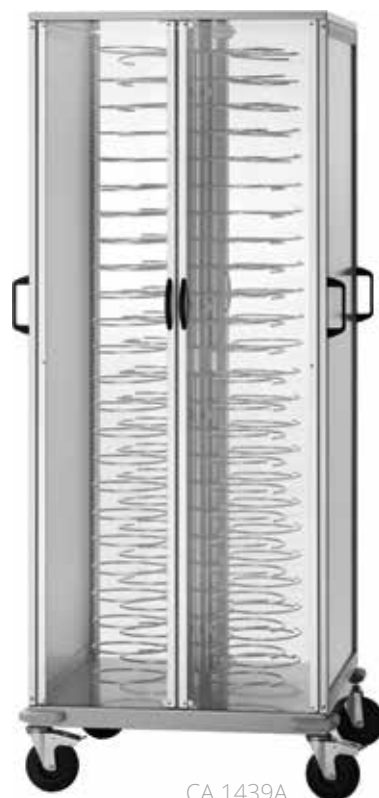

CA 1439A

	CA 1439A griglie verniciate painted grid	CA 1440A griglie cromate chrome-plated grill	CA 1439AG griglie verniciate painted grid	CA 1440AG griglie cromate chrome-plated grill
	75 x 78 x 183(h) cm			
	88 piatti / plates ø 18/23 cm	88 piatti / plates ø 18/23 cm	88 piatti / plates ø 25/31 cm	88 piatti / plates ø 25/31 cm
	1380 €	1390 €	1400 €	1410 €

+5%

## CG 1439AC

GRIGLIA  
PLASTIFICATA  
GN2/1  
PLASTIC  
COATED GRID  
GN2/1



IT Carrelli portapiatti armati e riscaldati. Struttura portante in acciaio plastificato - termostato regolabile - telaio in alluminio anodizzato - pannellatura in PERFEX con n. 4 sportelli apribili in plexiglass - griglie cromate-maniglie laterali per conduzione carrello - ruote ø 125 mm di cui due con freno.

EN Heated cabinet plate trolleys. Supporting structure in plastic-coated steel - adjustable thermostat - anodized aluminium frame - perfix panelling with 4 openable Plexiglas doors - painted or chrome-plated grids - side handles for trolley operation - multidirectional wheels ø 125 mm, two of which with brakes.

FR Chariots porte-assiettes chauffantes sur élément fermé. Structure portante en acier plastifié - thermostat réglable - corps en aluminium anodisé - panneaux en PERFEX avec 4 portes ouvrables en plexiglas - grilles chromées - poignées latérales pour le déplacement- roues ø 125 mm, dont deux avec frein.

DE Beheizter Tellerwagen und mit Schrankelement. Tragstruktur aus Kunststoffbeschichtetem Stahl. Einstellbarer Thermostat Rahmen aus eloxiertem Aluminium. Blenden in Perfix mit 4 Flügeltüren aus Plexiglas. Verchromte Gitter Seitliche Lenkergriffe - Räder diam. 125 mm, zwei davon mit Bremsen.

	CG 1439AC	
	800 + 800 W	
	230V/ 50-60 HZ	
	max 60°C	
	10 griglie verniciate GN2/1 / 10 painted grids GN2/1	
	75 x 78 x 177(h) cm	
	2250 €	

## CA 1440AC CA 1440ACG

GRIGLIA  
CROMATA  
CHROME  
PLATED GRID

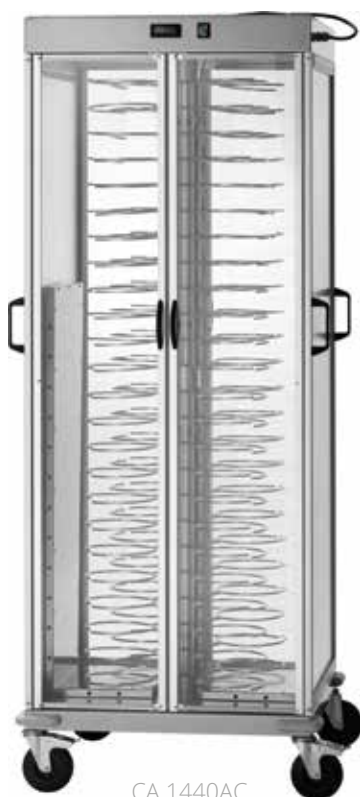

CA 1440AC

	CA 1440AC	CA1440ACG
	800 + 800 W	
	230V/ 50-60 HZ	
	max 60°C	
	88 piatti / plates ø 18/23 cm	88 piatti / plates ø 25/31 cm
	75 x 78 x 177(h) cm	
	2000 €	2060 €

Carrelli portapiatti armati riscaldati  
Heated cabinet plate trolleys

+5%

## CA 1439R CA 1439RG

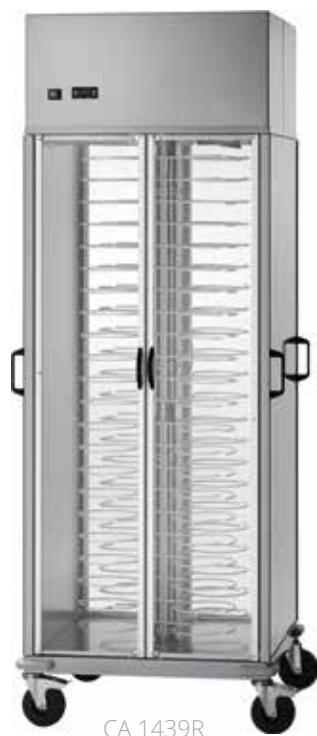

CA 1439R

IT Carrelli portapiatti refrigerati. Struttura portante in acciaio plastificato - telaio in alluminio anodizzato - pannellatura in isomac spessore 25 mm con 4 sportelli apribili in plexiglass- griglie plastificate - maniglie laterali per conduzione carrello - ruote ø 125 mm di cui due con freno.

EN Refrigerated cabinet plate trolleys Supporting structure in plastic-coated steel - anodized aluminium frame - isomac panelling with 25 mm thickness and 4 openable Plexiglas doors - plastic coated grids - side handles for trolley operation - multidirectional wheels ø 125 mm, two of which with brakes.

FR Chariots porte-assiettes réfrigérées. Structure portante en acier plastifié - corps en aluminium anodisé - panneaux en isomac épaisseur 25 mm avec 4 portes ouvrantes en plexiglas - grilles plastifiées - poignées latérales pour le déplacement - roues ø 125 mm dont deux avec frein.

DE Gekühlte Tellerwagen. Tragstruktur aus kunststoffbeschichtetem Stahl - Rahmen aus eloxiertem Aluminium - 25 mm starke Isomac-Blenden mit 4 Flügeltüren aus Plexiglas - kunststoffbeschichtete Gitter - seitliche Lenkergriffe - Räder ø 125 mm, zwei davon mit Bremsen.

i	CA 1439R	CA 1439RG	CG 1439R
⚡	460 W		
🔌 1 Ph	230V/ 50-60 HZ		
🌡️	+8°C - +12 °C		
🔥	R290		
🍽️	88 piatti / plates ø 18/23 cm	88 piatti / plates ø 25/31 cm	10 griglie x GN2/1 10 grills x GN2/1
↗️ cm	75 x 78 x 203(h) cm		
	2300 €	2350 €	2600 €

## CG 1439R



+5%



## CA 656 - CA 631 - CA 659



IT Carrelli per ritiro, distribuzione e stoccaggio vassoi, piatti, tazze, ecc. Telaio in acciaio inox - cesti asportabili in filo di acciaio plastificato - paracolpi - ruote multidirezionali ø 125 mm.

EN Trolleys for collecting, distributing and storing trays, plates, cups, etc. Stainless steel frame - removable baskets made of plastic-coated steel wire - shock absorbers - multidirectional wheels ø 125 mm.

FR Chariots de collecte, de distribution et de stockage de plateaux, assiettes, tasses, etc. Structure en acier inox - paniers amovibles en fil d'acier plastifié - butoirs - roues multidirectionnelles ø 125 mm.

DE Wagen zum Sammeln, Verteilen und Lagern von Tablett, Tellern, Tassen usw. Edelstahlrahmen - abnehmbare Körbe aus kunststoffbeschichtetem Stahldraht - Stoßschutz - Mehrwegräder ø 125 mm.

	CA 656	CA 631	CA 659
	88 x 50 x 92(h) cm	75 x 65 x 92(h) cm	88 x 105 x 98(h) cm
	1 cesto / basket	1 cesto / basket	2 cesto / baskets
	100 piatti / plates	130 vassoi / trays	200 piatti / plates
	340 €	270 €	500 €

**+5%**

## CA 1399 CA 1400 CA 1401



IT Carrello scolapiatti e bicchieri. Telaio in tubo di acciaio inox - ripiani con griglie in acciaio inox per piatti - vaschette scola bicchieri in acciaio inox - piano raccogliacqua in acciaio inox - ruote multidirezionali ø 125 mm.

EN Plates and glasses drainer trolley. Stainless steel tubular frame - shelves with stainless steel grids for plates - stainless steel glass draining trays - stainless steel drip tray - multidirectional wheels ø 125 mm.

FR Chariot égouttoir assiettes et verres. Structure en tube d'acier inox - étagères avec grilles en acier inox pour assiettes - plateaux d'égouttage pour les verres en acier inox - cuve de récupération en acier inox - roues multidirectionnelles ø 125 mm.

DE Geschirr und Gläser Abtropfwagen. Edelstahlrohrrahmen - Stellflächen mit Edelstahlgittern für Teller - Abtropfschalen für Gläser aus Edelstahl - Tropfschale aus Edelstahl - Mehrwegräder ø 125 mm.

	CA 1399	CA 1400	CA 1401
	110 x 62 x 134(h) cm		110 x 62 x 160(h) cm
	3 scolapiatti 3 plates drainers	1 scolabicchieri 1 glasses drainer 2 scolapiatti 2 plates drainers	4 scolapiatti 4 plates drainers
	510 €	590 €	630 €

Scolapiatti e bicchieri  
Plates and glasses drainer

Carrelli portapiatti per trasporto e ritiro  
Plates transport and collection trolleys

## SPB 1398



## SP 1397



- IT Pensili scolapiatti e bicchieri da muro. Struttura in acciaio inox lucido 18/8.
- EN Hanging plates and glasses drainer. Structure in 18/8 polished stainless steel.
- FR Égouttoir mural pour assiettes et verres. Structure en acier inox poli 18/8.
- DE Geschirr und Gläser Wandabtropfschränke. Struktur aus poliertem Edelstahl 18/8.

	SPB 1398	SP 1397
	80 x 26 x 37(h) cm	104 x 30 x 55(h) cm
	70 €	150 €

## CP 1442



- IT Carrelli portacestelli per lavastoviglie. Struttura tubolare in acciaio inox 50x50 cm. Ruote multidirezionali ø 125 mm - cestelli non inclusi.
- EN Dishwasher trolleys. Stainless steel tubular structure 50x50 cm. Multidirectional wheels ø 125 mm - baskets not included.
- FR Chariots pour lave-vaisselle. Structure tubulaire en acier inox 50x50 cm. Roues multidirectionnelles ø 125 mm - paniers pas compris.
- DE Spülmaschinenwagen. 50x50 cm Edelstahlrohrstruktur. Mehrwegräder ø 125 mm - Körbe nicht enthalten.

	CP1442
	65 x 65 x 170(h) cm
	280 €

 114 Scolapiatti e bicchieri  
Plates and glasses drainer

**+5%**

Carrello portacestelli  
Basket trolley

**forcar**<sup>®</sup>

CP 1447  
CP 1448



CP 1447

CP 1445  
CP 1446



CP 1445

IT Carrelli portacestelli per lavastoviglie. Vasca in ABS - disponibile con o senza manico in acciaio inox - ruote multidirezionali ø 125 mm - cestelli non inclusi.

EN Dishwasher basket trolleys. ABS base - available with or without stainless steel handle - multidirectional wheels ø 125 mm - baskets not included.

FR Chariots porte-paniers pour lave-vaisselle. Fond en ABS - disponible avec ou sans poignée en acier inox - roues multidirectionnelles ø 125 mm - paniers pas compris.

DE Korbwagen für Geschirrspülerkörbe. ABS-Boden - mit oder ohne Edelstahlgriff erhältlich - Mehrwegräder ø 125 mm - Körbe nicht enthalten.

IT Carrelli portacestelli per lavastoviglie. Vasca in acciaio inox - disponibile con o senza manico in acciaio inox - ruote multidirezionali ø 125 mm. Ceste non incluse.

EN Dishwasher basket trolleys. Stainless steel base - available with or without stainless steel handle - multidirectional wheels ø 125 mm. Baskets not included.

FR Chariots porte-paniers pour lave-vaisselle. Fond en acier inox - disponible avec ou sans poignée en acier inox - roues multidirectionnelles ø 125 mm. Paniers pas compris.

DE Korbwagen für Geschirrspülerkörbe. Edelstahl Boden - mit oder ohne Edelstahlgriff erhältlich - Mehrwegräder ø 125 mm, Körbe nicht enthalten.

	CP 1447 con manico - with handle	CP 1448 senza manico - without handle
	53 x 56 x 92(h) cm	53 x 56 x 21(h) cm
	120 €	85 €

	CP 1445 con manico - with handle	CP 1446 senza manico - without handle
	52 x 58 x 96(h) cm	52 x 52 x 20(h) cm
	210 €	190 €

+5%

Carrello portacestelli  
Basket trolley

OPTIONAL



## CB 1444 - CB 1443



CB 1444

IT Carrelli per impasti pizza con cassette da 60x40 cm - interamente in acciaio inox - disponibile con o senza manico in acciaio inox - ruote multidirezionali ø 125 mm.

EN Pizza dough trolleys with 60x40 cm containers - entirely made of stainless steel - available with or without stainless steel handle - multidirectional wheels ø 125 mm.

FR Chariots à pâte à pizza avec bacs de 60x40 cm - entièrement en acier inox - disponible avec ou sans poignée en acier inox - roues multidirectionnelles ø 125 mm.

DE Pizzateigwagen mit 60x40 cm Behälter - komplett aus Edelstahl - mit oder ohne Edelstahlgriff erhältlich - Mehrwegräder ø 125 mm.

	CB 1444 con manico - with handle	CB 1443 senza manico - without handle
	72 x 42 x 96(h) cm	62 x 42 x 20(h) cm
	200 €	185 €

## CB 1449



IT Carrello portacassette per impasti pizza 60x40 cm - senza manico - vasca in ABS - ruote multidirezionali ø 125 mm.

EN Trolley for Pizza dough containers 60x40 cm - without handle - ABS base - multidirectional wheels ø 125 mm.

FR Chariot à bacs pour pâte à pizza 60x40 cm - sans poignée - fond en ABS - roues multidirectionnelles ø 125 mm.

DE Wagen für Pizzateigbehälter 60x40 cm - ohne Griff - ABS-Boden - Mehrwegräder ø 125 mm.

	CB 1449
	62 x 42 x 16,5(h) cm
	60 €

**+5%**

 Carrelli portacassette per impasti pizza  
Trolley for pizza dough container

**forcar**<sup>®</sup>

# Cestelli per lavastoviglie 50x50 cm

Dishwasher baskets 50x50 cm  
Paniers pour lave-vaisselle 50x50 cm  
Körbe für Geschirrspüler 50x50 cm



i	BVM	BV	B9	B16	B25	B36	B49	BP	BA
	base vuota h 90 mm col. grigio per posate	base vuota h 90 mm col. grigio universale	base 9 scomparti h 90 mm col. grigio (bicchiere diam. 140 mm)	base 16 scomparti h 90 mm col. grigio (bicchiere diam. 110 mm)	base 25 scomparti h 90 mm col. grigio (bicchiere diam. 80 mm)	base 36 scomparti h 90 mm col. grigio (bicchiere diam. 70 mm)	base 49 scomparti h 90 mm col. grigio (bicchiere diam. 60 mm)	base per piatti o vassoi h 90 mm col. grigio	base per vassoi aperto su un lato h 90 mm col. grigio
	20 €	20 €	22 €	23 €	24 €	25 €	28 €	21 €	22 €

i	RIAU	RIA9	RIA25	RIA36	RIA49	RIA16	CP8	COPCEST
	rialzo universale h 45 mm col. blu	rialzo 9 scomparti h 45 mm col. blu	rialzo 25 scomparti h 45 mm col. blu	rialzo 36 scomparti h 45 mm col. blu	rialzo 49 scomparti h 45 mm col. blu	rialzo 16 scomparti h 45 mm col. blu	cestellino inserto portaposate 8 scomparti	coperchio standard per cestelli
	10 €	11 €	11 €	11 €	12 €	11 €	13 €	15 €

+5%

Cestelli per lavastoviglie  
Dishwasher baskets



# Carrelli e articoli per il servizio in camera

TROLLEYS AND EQUIPMENT  
FOR ROOM SERVICE  
CHARIOTS ET ARTICLES  
DE ROOM SERVICE  
WAGEN UND AUSRÜSTUNG  
FÜR DEN ZIMMERSERVICE

## CB 980

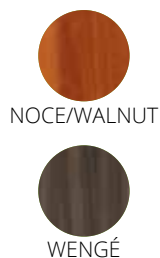

CB 980

Esclusa cassetta  
Boxes not included

## CB 970

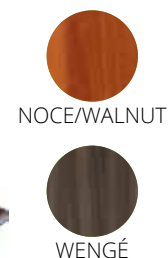

CB 970W

Esclusa cassetta  
Boxes not included

IT Carrelli per la colazione. Struttura portante in tubo di acciaio inox - ripiano con antine ribaltabili in nobilitato - disponibile nei colori noce o wengé - ripiano di servizio ruotabile sino a 90°, con possibilità di incastrare i carrelli uno dentro l'altro per ridurre al minimo l'ingombro. Ruote multidirezionali di cui 2 con freno.

EN Breakfast trolleys. Supporting structure in stainless steel tube - shelf with melamine folding doors - available in walnut or wengé colour - service shelf that can be rotated up to 90°, trolleys can be pushed one inside the other to reduce the overall dimensions considerably. Multidirectional wheels, 2 with brake.

FR Chariots pour le petit déjeuner. Structure portante en tube d'acier inox - plan de travail avec volets en mélaminé - disponible en noyer ou wengé - plan de service pivotant jusqu'à 90°, les chariots peuvent être rangés les uns dans les autres pour réduire l'encombrement au minimum. Roues multidirectionnelles, dont 2 avec frein.

DE Frühstückswagen. Tragstruktur aus Edelstahlrohr - Abstellfläche mit Klapptüren aus Melamin - erhältlich in den Farben Nussbaum oder Wenge - bis zu 90° drehbare Ablagefläche, Wagen ineinander stapelbar, um die Außenmaße höchst möglichst zu reduzieren. Mehrwegräder, davon 2 mit Bremse.

+5%

i	CB 980 noce-walnut	CB 980W wengé
↗ cm	Open ø 80 x 80(h) cm Closed 80 x 53 x 80(h) cm	
415 €		

i	CB 970 noce-walnut	CB 970W wengé
↗ cm	Open 80 x 53 x 80(h) cm Closed 35 x 53 x 80(h) cm	
415 €		

Carrelli per la colazione  
Breakfast trolleys

## CST 300







IT Casseta termica per scaldare piatti e prime colazioni. Contenitore interamente in acciaio inox - termostato regolabile.

EN Heating box to warm plates and breakfasts. Container entirely in stainless steel - adjustable thermostat

FR Boîte thermique pour réchauffer les assiettes et les petits déjeuners. Corps entièrement en acier inox - thermostat réglable

DE Wärmekiste zum Erwärmen von Teller und Frühstück. Kiste komplett aus Edelstahl - einstellbarer Thermostat.

	CST 300
	250 W
 1 Ph	230V/ 50-60 HZ
	+30° +90°C
 cm	39 x 37 x 46(h) cm
	<b>330 €</b>

## CPC 600

Cassette termiche non incluse  
Boxes not included



IT Carrello porta cassette termiche Mod. CTS300 con allacciamento elettrico. Struttura tubolare 25x25 cm in acciaio inox - guide per contenere n.6 cassette termiche. Ruote ø 125 mm di cui 2 con freno. Cassette non incluse.

EN Heating boxes trolley Mod. CTS300 with electrical connection. Tubular structure 25x25 cm in stainless steel - slides to store 6 heating boxes. Wheels ø 125 mm 2 of which with brake. Boxes not included.

FR Chariot à boîtes thermiques Mod. CTS300 avec connexion électrique. Structure en tube d'acier inox 25x25 cm - glissières pour contenir 6 boîtes thermiques. Roues ø 125 mm dont 2 avec frein. Boîte pas compris.

DE Wagen für Wärmekiste Mod. CTS300 mit elektrischem Anschluss. Rohrstruktur 25x25 cm aus Edelstahl - Führungen für 6 Wärmekisten. Räder ø 125 mm davon 2 mit Bremse. Wärmekisten nicht enthalten.

**+5%**

	CPC 600
 1 Ph	230V/ 50-60 HZ
 cm	155 x 61 x 132(h) cm
	<b>400 €</b>



PV 4055



PV 4056



PV 4062



PV 4064



IT Carrelli portavaligie e portabiti. Base in legno ricoperta da moquette colorata, disponibile nei colori rosso o blu - supporto asta in tubolare di acciaio ottonato o cromato da  $\varnothing$  40 mm - bordo paracolpi perimetrale in gomma - ruote multidirezionali  $\varnothing$  200 mm.

FR Chariots à bagages et porte-vêtements. Base en bois recouverte de moquette, disponible en rouge ou bleu - Support en tube d'acier tubulaire en laiton ou chromé  $\varnothing$  40 mm - Bord de butoir périphérique en caoutchouc - Roues multidirectionnelles  $\varnothing$  200 mm.

EN Luggage trolleys and clothes racks. Wooden base covered with coloured carpet, available in red or blue - rod support in brass-plated or chrome-plated steel tube  $\varnothing$  40 mm - perimeter rubber shock absorber - multidirectional wheels  $\varnothing$  200 mm.

DE Kofferwagen und Kleiderständer. Holzboden mit buntem Teppichboden, erhältlich in den Farben Rot oder Blau - Stabhalterung aus vermessingt oder verchromtem Stahlrohr  $\varnothing$  40 mm - Gummistoßschutz - Mehrrichtungsräder  $\varnothing$  200 mm.

	PV 4062	PV 4064	PV 4055	PV 4056
				
	95 x 55 x 190(h) cm		95 x 55 x 183(h) cm	
	Base rossa + Struttura ottone Red base + Brass structure	Base blu + Struttura cromata Blue base + Chromed structure	Base rossa + Struttura ottone Red base + Brass structure	Base blu + Struttura cromata Blue base + Chromed structure
	150 Kg			
	860 €	830 €	730 €	670 €

Carrelli portavaligie e portabiti  
Luggage trolleys and clothes racks

+5%

PV 2001

PV 2001I



WARNING

PV 2021

PV 2021I



IT Carrelli portavaligie e portabiti. Base in legno ricoperta da moquette colorata, disponibile in rosso - supporto asta in tubolare di acciaio ottonato o inox da  $\varnothing$  mm 40 mm - bordo paracolpi perimetrale in gomma - ruote multidirezionali  $\varnothing$  200 mm.

IT Carrelli portavaligie e portabiti. Base in legno ricoperta da moquette colorata, disponibile nei colori rosso o nera - supporto asta in tubolare di acciaio ottonato o inox da  $\varnothing$  40 mm - bordo paracolpi perimetrale in gomma - ruote pneumatiche  $\varnothing$  200 mm.

EN Luggage trolleys and clothes racks. Wooden base covered with coloured carpet, available in red - rod support in brass-plated steel or stainless steel tube  $\varnothing$  40 mm - perimeter rubber shock absorber - multidirectional wheels  $\varnothing$  200 mm.

EN Luggage trolleys and clothes racks. Wooden base covered with coloured carpet, available in red or black - rod support in brass-plated steel or stainless steel tube  $\varnothing$  40 mm - perimeter rubber shock absorber - pneumatic wheels  $\varnothing$  200 mm.

FR Chariots à bagages et porte-vêtements. Base en bois recouverte de moquette, disponible en rouge - support en tube d'acier tubulaire en laiton ou acier inox  $\varnothing$  40 mm - bord de butoir périphérique en caoutchouc - roues multidirectionnelles  $\varnothing$  200 mm.

FR Chariots à bagages et porte-vêtements. Base en bois recouverte de moquette, disponible en rouge ou noir - support en tube d'acier tubulaire en laiton ou acier inox  $\varnothing$  40 mm - bord de butoir périphérique en caoutchouc - roues pneumatiques  $\varnothing$  200 mm.

DE Chariots à bagages et porte-vêtements. Base en bois recouverte de moquette, disponible en rouge - support en tube d'acier tubulaire en laiton ou acier inox  $\varnothing$  40 mm - bord de butoir périphérique en caoutchouc - roues multidirectionnelles  $\varnothing$  200 mm.

DE Kofferwagen und Kleiderständer. Holzboden mit buntem Teppichboden, erhältlich in den Farben Rot oder Schwarz - Stabhalterung aus vermessingt Stahl oder Edelstahlrohr  $\varnothing$  40 mm - Gummistoßschutz - Lufräder  $\varnothing$  200 mm.

i	PV 2001	PV 2001I
cm	124 x 64 x 190(h) cm	
	Base rossa + Struttura ottone Red base + Brass structure	Base rossa + Struttura inox Red base + Stainless steel structure
MAX Kg	150 Kg	
	900 €	840 €

i	PV 2021	PV 2021I
cm	110 x 62 x 198(h) cm	
	Base rossa + Struttura ottone Red base + Brass structure	Base nero + Struttura inox Black base + Stainless steel structure
MAX Kg	150 Kg	
	980 €	920 €

122 Carrelli portavaligie e portabiti  
Luggage trolleys and clothes racks

+5%



WARNING!

IL CARRELLO VIENE SPEDITO IN KIT SMONTATO  
THE TROLLEY IS DELIVERED DISMOUNTED  
LE CHEROÏT EST LIVRÉ DEMONTÉ  
DER WAGEN IST DEMONTIERT GELIEFERT

car

PV 2002

PV 2002I

PV 2003

PV 2003I



IT Carrelli portavaligie. Base pieghevole e piani in legno ricoperti di moquette colorata rossa - struttura disponibile in acciaio ottonato o inox - 2 piedi di appoggio - ruote ø 250 mm.

EN Luggage trolleys. Foldable base and wooden shelves covered with red carpet - structure available in brass or stainless steel - 2 support feet - wheels ø 250 mm.

FR Chariot à bagages. Base repliable et étagères en bois recouvertes de moquette de couleur rouge - structure disponible en acier laitonné ou en acier inox - 2 pieds de support - roues ø 250 mm.

DE Kofferwagen. Klappboden und Holzabstellflächen mit rotem Teppichboden - Struktur wahlweise aus vermessingtem Stahl oder Edelstahl - 2 Standfüße - Räder ø 250 mm.

i	PV 2002	PV 2002I	PV 2003	PV 2003I
↗ cm	56 x 83 x 123(h) cm		56 x 70 x 120(h) cm	
	Base rossa + Struttura ottone Red base + Brass structure	Base rossa + Struttura inox Red base + Stainless steel structure	Base rossa + Struttura ottone Red base + Brass structure	Base rossa + Struttura inox Red base + Stainless steel structure
MAX Kg	100 Kg			
	260 €	230 €	220 €	190 €

+5%

## PVI 4024



IT Carrello porta valigie e portabiti. Struttura in tubo di acciaio inox - base in lamiera d'acciaio inox - ruote multidirezionali  $\varnothing$  140 mm, di cui 2 fisse.

EN Luggage trolley and clothes rack Structure in stainless steel tube - base in stainless steel plate - multidirectional wheels  $\varnothing$  140 mm, 2 of which fixed.

FR Chariots à bagages et porte-vêtements. Structure en tube d'acier inox - base en tôle d'acier inox - roues multidirectionnelles  $\varnothing$  140 mm, dont 2 fixes.

DE Kofferwagen und Kleiderständer. Struktur aus Edelstahlrohr - Boden aus Edelstahlblech - Mehrwegräder  $\varnothing$  140 mm, 2 davon fest.

## ST 4060



IT Stender portabiti. Struttura in tubo di acciaio cromato - asta allungabile di 30 cm per lato - ruote multidirezionali.

EN Clothes rack. Chrome-plated steel tube structure - rod can be extended by 30 cm on each side - multidirectional wheels.

FR Vêtements rack. Structure en tube d'acier chromé - bras extensible de 30 cm de chaque côté - roues multidirectionnelles.

DE Kleiderständer. Verchromte Stahlrohrstruktur - der Stab lässt sich auf jeder Seite um 30 cm verlängern - Mehrwegräder.

	PVI 4024
	100 x 56 x 160(h) cm
	200 Kg
	375 €

+5%

	ST 4060
	Open 210 x 53 x 152(h) cm Closed 150 x 53 x 152(h) cm
	90 €

## RE 4016 - RE 4017



RE 4016



## RE 4018 - RE 4019



RE 4019



IT Reggivaligie. Struttura in legno - telo in cotone.

EN Luggage holder. Wooden structure - cotton strap.

FR Supports de bagages. Structure en bois - toile de coton.

DE Kofferträger. Holzrahmen - Baumwolltuch.

	RE 4016 faggio-beech wood	RE 4017 noce-walnut
	50 x 46 x 58(h) cm	
	55 €	

	RE 4018 faggio-beech wood	RE 4019 noce-walnut
	50 x 41 x 58(h) cm	
	55 €	

**+5%**

Reggi valigie  
Luggage holder

## CPB 1472 - CPB 1474



IT Carrello per trasporto pesante. Pianale basso in lamiera di acciaio inox - manico smontabile - 2 ruote multidirezionali ø 140 mm di cui 2 fisse.

EN Trolleys for heavy transport Lower platform in stainless steel plate - removable handle - 2 multidirectional wheels ø 140 mm, 2 of which fixed.

FR Chariot de transport lourd. Etagère basse en tôle d'acier inox - poignée amovible - 2 roues multidirectionnelles ø 140 mm, dont 2 fixes.

DE Wagen für den Schwertransport. Niedrige Ladefläche aus Edelstahlblech - abnehmbarer Griff - 2 Mehrwegräder ø 140 mm, 2 davon fest.

DE

	CPB 1474	CPB 1472
 cm	61 x 122 x 90(h) cm	61 x 110 x 85(h) cm
	<b>1 manico</b> <b>1 handle</b>	<b>2 manici</b> <b>2 handles</b>
 MAX Kg	200 Kg	
	<b>310 €</b>	<b>335 €</b>

## CA 1473



IT Carrello portacasse. Struttura in tubo di acciaio verniciato - ruote ø 200 mm piene.

EN Trunk trolley. Structure in painted steel tube - ø 200 mm full wheels.

FR Chariot pour caisse. Structure en tube d'acier peint - roues pleines ø 200 mm.

DE Kistenwagen. Struktur aus lackiertem Stahlrohr - ø 200 mm Vollräder.

	CA 1473
 cm	50 x 45 x 105(h) cm
 MAX Kg	200 Kg
	<b>125 €</b>

# ACF 5190



IT Aste delimita corsie. Disponibili in diverse misure con nastro avvolgibile colorato rosso o blu - asta colore oro, acciaio inox o nera. Puntali in abbinamento.

EN Retractable Barriers Available in different sizes with red or blue colored retractable belts - gold, stainless steel or black post. Matching caps.

FR Délimiteur de zone. Disponible en différentes tailles avec ruban roulant de couleur rouge ou bleue - mât en or, acier inox ou noir. Pointe coordonnée.

DE Begrenzungspfosten. Erhältlich in verschiedenen Größen mit rotem oder blauem Aufrollband - Gold, Edelstahl oder schwarze Pfosten. Passende Spitzen.



## PU 5195

IT Puntali in abbinamento delle aste delimita corsie a seconda del colore e materiale scelto.

EN Caps matching the posts of the retractable barriers according to the colour and material chosen.

FR Pointes coordonnées avec les mâts de délimitation des voies en fonction de la couleur et du matériau choisi.

DE Spitzen passend zu den Begrenzungspfosten je nach Farbe und Material.

	ACF 5190 DB Blu-Blue	ACF 5190 DR Rosso-Red
	2 mt	
	Asta dorata Golden post	
	ACF 5190 IB Blu-Blue	ACF 5190 IR Rosso-Red
	2 mt	
	Asta acciaio lucido Polished steel post	
	ACF 5190 NB Blu-Blue	ACF 5190 NR Rosso-Red
	2 mt	
	Asta nera Black post	
	80 €	

	PU 5195 DB Blu-Blue	PU 5195 DR Rosso-Red	PU 5195 IB Blu-Blue	PU 5195 IR Rosso-Red	PU 5195 NB Blu-Blue	PU 5195 NR Rosso-Red
	Puntale dorato Gold cap		Puntale acciaio lucido Polished steel cap		Puntale nero Black cap	
	35 €					

Aste delimita corsia  
Retractable barriers

+5%

## AC 5118D AC 5118I



IT Aste delimita corsie per cordoni a treccia. Puntali in abbinamento.  
EN Barriers posts for plaited cords. Matching caps.  
FR Délimiteur de zone pour cordons tressés. Pointe coordonnée.  
DE Begrenzungsposten für geflochtene Seile. Passende Spitzen.

i	AC 5118D	AC 5118I
↗ cm	90(h) cm	
	Asta dorata Golden post	Asta acciaio lucido Polished steel post
	80 €	

+5%

## GA 5144D - GA 5144I

IT Gancio a muro, disponibile in colore ottonato o cromato.  
EN Wall ring, available in brass or chrome colour.  
FR Anneau à mur, disponible en couleur laiton ou chromé.  
DE Wandhaken, erhältlich in vermessingter oder verchromter Farbe.



i	GA 5144D	GA 5144I
	Gancio ottonato Brass-plated wall ring	Gancio inox Stainless steel wall ring
	18 €	

## CO 4099

IT Cordone per aste. Colori: bordeaux, oro, verde, blu.  
EN Barriers cord. Colours: burgundy, gold, green, blue.  
FR Cordon pour délimiteur. Couleurs: bordeaux, or, vert, bleu.  
DE Begrenzungsseile. Farben: Burgunder, Gold, Grün, Blau.



i	CO4099	
↗ cm	ø 30 mm	
	30 € al metro / meter	

## PU 5144D - PU 5144I

IT Puntali in abbinamento delle aste delimita corsie per cordoni a treccia.  
EN Caps matching the posts of the barriers with plaited cords.  
FR Pointes coordonnées avec les mâts pour cordons tressés.  
DE Spitzen passend zu den Begrenzungsposten für geflochtene Seile.



i	PU 5144D	PU 5144I
	Puntale dorato Gold cap	Puntale acciaio lucido Polished steel cap
	20 €	

+5%



## LU 4120



## LU 4131



IT Macchina pulisci scarpe. Struttura in lamiera verniciata a polveri epossidiche - spazzole in cotone e crine - pulsante di accensione con temporizzatore elettrico. Distributore per crema - disponibile solo in colore bianco.

EN Shoe cleaner machine. Structure in metal plate painted with epoxy powders - cotton and horsehair brushes - power button with electric timer. Cream dispenser - available colors white.

FR Machine de nettoyage de chaussures. Structure en tôle peinte avec poudres époxy - brosses en coton et crin de cheval - bouton d'alimentation avec minuterie électrique. Distributeur de crème - disponible en blanc.

DE Schuhputzmaschine. Struktur aus mit Epoxidpulvern lackiertem Blech - Baumwoll- und Rosshaarbürsten - Einschaltknopf mit elektrischer Zeitschaltuhr. Cremespender - erhältlich in weiß.

IT Macchina pulisci scarpe. Struttura in lamiera verniciata a polveri epossidiche - spazzole in cotone e crine - pulsante di accensione con temporizzatore elettrico.

EN Shoe cleaner machine. Structure in metal plate painted with epoxy powders - cotton and horsehair brushes - power button with electric timer.

FR Machine de nettoyage de chaussures. Structure en tôle peinte avec poudres époxy - brosses en coton et crin de cheval - bouton d'alimentation avec minuterie électrique.

DE Schuhputzmaschine. Struktur aus mit Epoxidpulvern lackiertem Blech - Baumwoll- und Rosshaarbürsten - Einschaltknopf mit elektrischer Zeitschaltuhr.

	LU 4120
	150 W
 1 Ph	230V-50HZ
 cm	62 x 30 x 83(h) cm
	790 €

	LU 4131
	150 W
 1 Ph	230V-50HZ
 cm	42 x 30 x 83(h) cm
	600 €

**+5%**

Macchine pulisci scarpe  
Shoe cleaner machines



# Carrelli portabiancheria

riifornimento frigobar,pulizia e multiuso

LAUNDRY, MINIBAR, CLEANING  
AND MULTI-PURPOSE TROLLEYS.  
CHARIOTS À LINGE, REPLISSAGE MINIBAR,  
NETTOYAGE ET POLYVALENT.  
WÄSCHEREI-, MINIBAR-, REINIGUNGS- UND  
MEHRZWECKWAGEN.

## CA 1501



## CA 1505



## CA 1510



## CA 1515



IT Carrelli portabiancheria. Struttura in acciaio inox - piani in laminato - in dotazione un sacco in tessuto ignifugo - paracolpi in gomma - ruote multidirezionali ø 125 mm.

EN Laundry trolleys. Stainless steel structure - laminate shelves - fireproof fabric bag included - rubber shock absorbers - multidirectional wheels ø 125 mm.

FR Chariots à linge. Structure en acier inox - dessus en stratifié - sac en tissu ignifuge inclus - butoir en caoutchouc - roues multidirectionnelles ø 125 mm.



DE Wäschereiwagen. Edelstahlstruktur - Laminatoberflächen - feuerfester Gewebesack inbegriffen - Gummistoßschutz - Mehrwegräder ø 125 mm.



NOCE/WALNUT



WENGÉ

	CA 1501 noce-walnut	CA 1505 noce-walnut	CA 1505W wengé	CA 1510 noce-walnut	CA 1510W wengé	CA 1515 noce-walnut	CA 1515W wengé
	79 x 43 x 129(h) cm	70/100 x 50 x 123(h) cm		90/143 x 50 x 123(h) cm		110/143 x 50 x 123(h) cm	
	3	4		4		4	
	-	1 bracciaio pieghevole 1 folding arm		2 braccia pieghevoli 2 folding arms		2 braccia pieghevoli 2 folding arms	
	270 €	480 €		520 €		530 €	

**+5%**

Carrelli portabiancheria  
Laundry trolleys

OPTIONAL



## CA 740



NOCE/WALNUT



## CA 1525



INOX



IT Carrello portabiancheria. Struttura in acciaio inox - piani in laminato - 2 portasacchi, in dotazione un sacco in tessuto ignifugo - cassetto superiore portaccessori - paracolpi in gomma - ruote multidirezionali  $\varnothing$  125 mm.

EN Laundry trolley. Stainless steel structure - laminate shelves - 2 bag holders, supplied with a fireproof fabric bag - upper drawer for accessories - rubber shock absorber - multidirectional wheels  $\varnothing$  125 mm.

FR Chariot à linge. Structure en acier inox - étagères en stratifié - 2 porte-sacs, fournis avec un sac en tissu ignifugé - tiroir supérieur porte-accessoires - butoir en caoutchouc - roues multidirectionnelles  $\varnothing$  125 mm.

DE Wäschereiwagen. Edelstahlstruktur - Laminatoberflächen - 2 Sackhalter, feuerfester Gewebesack inbegriffen - obere Schublade für Zubehörteile - Gummistoßschutz - Mehrwegräder  $\varnothing$  125 mm.



IT Carrello portabiancheria. Struttura in acciaio inox - piani in acciaio inox - 2 portasacchi, in dotazione un sacco in tessuto ignifugo - cassetto superiore portaccessori in acciaio inox - paracolpi in gomma - ruote multidirezionali  $\varnothing$  125 mm.

EN Laundry trolley. Stainless steel structure - stainless steel shelves - 2 bag holders, supplied with a fireproof fabric bag - stainless steel upper drawer for accessories - rubber shock absorber - multidirectional wheels  $\varnothing$  125 mm.

FR Chariot à linge. Structure en acier inox - étagères en acier inox - 2 porte-sacs, fournis avec un sac en tissu ignifugé - tiroir supérieur porte-accessoires en acier inox - butoir en caoutchouc - roues multidirectionnelles  $\varnothing$  125 mm.

DE Wäschereiwagen. Edelstahlstruktur - Edelstahloberflächen - 2 Sackhalter, feuerfester Gewebesack inbegriffen - obere Schublade aus Edelstahl für Zubehörteile - Gummistoßschutz - Mehrwegräder  $\varnothing$  125 mm.

	CA 740 noce-walnut
	82/152 x 50 x 158(h) cm
	4 piani + cassetta 4 layers + upper drawers
	2 braccia pieghevoli 2 folding arms
	<b>750 €</b>

	CA 1525 inox
	82/152 x 50 x 158(h) cm
	4 piani + cassetta 4 layers + upper drawers
	2 braccia pieghevoli 2 folding arms
	<b>800 €</b>

**+5%**

# CA 1530



IT Carrello portabiancheria, pulizia e multiuso. Struttura in lamiera verniciata a polveri epossidiche - 2 portasacchi, in dotazione un sacco in tessuto ignifugo - vaschetta porta detersivi superiore - ruote ø 140 mm, di cui 2 fisse e 2 girevoli.

EN Laundry, cleaning and multi-purpose trolley. Structure in epoxy powder coated sheet - 2 bag holders, supplied with a fireproof fabric bag - upper detergent tray - wheels ø 140 mm, 2 of which fixed and 2 swivelling.

FR Chariot à linge, nettoyage et polyvalent. Structure en tôle d'acier peinte avec des poudres époxydiques - 2 porte-sacs, fournis avec un sac en tissu ignifugé - plateau supérieur à détergent - roues ø 140 mm, dont 2 fixes et 2 pivotantes.

DE Wäscherei-, Reinigungs- und Mehrzweckwagen. Struktur aus mit Epoxidpulvern beschichtetem Blech - 2 Sackhalter, feuerfester Gewebesack inbegriffen - obere Waschmittelablage - Räder ø 140 mm, davon 2 fest und 2 schwenkbar.

	CA 1530
	80/153 x 50 x 158(h) cm
	3 piani + 2 portasacchi 3 layers + 2 bag holders
	2 braccia pieghevoli 2 folding arms
	<b>960 €</b>

Carrelli portabiancheria, pulizia e multiuso.  
Laundry cleaning and multi-purpose trolleys.

## Optional

A 520  
CA1501 - CA1505 - CA1510 - CA1515 - CA1530 - CA740  
CA1525 - CA1530

sacco in tela ignifugo  
fireproof fabric bag sac  
en tissu ignifugé  
feuerfester Gewebesack

**60 €**

A 515  
CA1501 - CA1505 - CA1510 - CA1515 CA1530 - CA740 - CA1525

Ruote con freno  
Wheels with brake  
Roues avec frein  
Räder mit Bremsen

**10 € cad./each**

A 518  
CA1530

Ruote con freno  
Wheels with brake  
Roues avec frein  
Räder mit Bremsen



**22 € cad./each**

**+5%**

# CR 1696





IT Carrello rifornimento frigo e multuso. Struttura in lamiera verniciata a polveri epossidiche - vaschetta laterale per la raccolta dei vuoti, asportabile - ruote ø 140 mm, di cui 2 fisse e 2 girevoli.

EN Multipurpose and mini bar filling trolley. Structure in epoxy powder coated plate - side tray for collecting dirt, removable - wheels ø 140 mm, of which 2 fixed and 2 swivelling.

FR Chariot pour le remplissage mini bar et polyvalent. Structure en tôle peinte à la poudre époxy - plateau latéral de vidange, démontable - roues de ø 140 mm, dont 2 fixes et 2 pivotantes.

DE Minibar- und Mehrzweckwagen. Struktur aus mit Epoxidpulvern beschichtetem Blech - seitliche Ablage zum Entleeren, abnehmbar - Räder ø 140 mm, davon 2 fest und 2 drehbar.

	CR 1696
	80 x 50 x 118(h) cm
	4 vaschette / side trays
<b>780 €</b>	

**+5%**

## Optional

A 1001	A 1002
Cestino piccolo Small basket Petit panier Kleiner Korb	Cestino grande Large basket Grand panier Großer Korb
<b>10 €</b>	<b>25 €</b>

A 518
Ruote con freno Wheels with brake Roues avec frein Räder mit Bremsen
<b>22 € cad./each</b>



**+5%**



CA 1696  
CON OPTIONAL  
WITH OPTIONAL

## CA 3203

**OPTIONAL**  
A 525

Sacco a tela  
Fabric bag  
Sac de toile  
Gewebesack

45 €



+5%

- IT Cestone portabiancheria pieghevole con sacco in tela e ruote multidirezionali.
- EN Folding laundry basket with fabric bag and multidirectional wheels.
- FR Sac à linge pliable avec sac en toile et roues multidirectionnelles.
- DE Faltbarer Wäschekorb mit Gewebesack und Mehrwegräder.

	CA 3203
	62 x 64 x 100(h) cm
	200 €

## CA 1580

**OPTIONAL**  
A 521

Sacco a tela  
Fabric bag  
Sac de toile  
Gewebesack

68 €



- IT Cesto pieghevole plastificato. Struttura in tubo e tondino di acciaio elettroverniciato - ruote multidirezionali.
- EN Plastic-coated folding basket. Structure in electro-varnished steel tube and rod - multidirectional wheels.
- FR Corbeille pliante plastifié. Structure en tube et tige d'acier électrovernissé - roues multidirectionnelles.
- DE Faltbarer Kunststoffwäschekorb. Struktur aus elektrolackiertem Stahlrohr - Mehrwegräder.

	CA 1580
	80 x 52 x 72(h) cm
	95 €

## CA 1584

**OPTIONAL**  
A 531

Sacco a tela  
Fabric bag  
Sac de toile  
Gewebesack

72 €



	CA 1584
	100 x 60 x 87(h) cm
	240 €

Cestone e carrelli con cesto per biancheria  
Basket and trolleys with laundry basket

+5%

## CA 1599



## CA 1599E



IT Secchio carrellato con strizzatore. Struttura di rialzo per inserimento prodotti pulizia - manico cromato ad incastro con impugnatura in gomma antiscivolo.

EN Bucket with wringer on wheels. Elevated structure for the insertion of cleaning products - chromed handle with non-slip rubber grip.

FR Seau sur roues avecessoreuse. Structure de rehausse pour l'insertion des produits de nettoyage - manche chromé avec poignée antiglisse en caoutchouc.

DE Fahrbarer Mopp Eimer mit Presse. Erhöhte Struktur für den Einsatz von Reinigungsmitteln - verchromter Griff mit rutschfestem Gummigriff.

IT Secchio carrellato con strizzatore.

EN Bucket with wringer on wheels.

FR Seau sur roues avecessoreuse.

DE Fahrbarer Mopp Eimer mit Presse.

	CA 1599
	55 x 27 x 87(h) cm
	140 €

	CA 1599E
	60 x 40 x 92(h) cm
	80 €

+5%



## CA 1604



IT Secchio carrellato con strizzatore in nylon - 2 secchi da 25 L - maniglione reversibile - ruote multidirezionali da  $\varnothing$  80 mm.

EN Bucket with nylon wringer on wheels - 2x25 L buckets - reversible handle - multidirectional wheels  $\varnothing$  80 mm.

FR Seau sur roue avec essoreuse en nylon - 2 seaux de 25 litres - poignée réversible - roues multidirectionnelles  $\varnothing$  80 mm.

DE Fahrbarer Mopp Eimer mit Nylonpresse - 2x25 L. Eimer - Wendegriff - Mehrwegräder  $\varnothing$  80 mm.

## CA 1604E





IT Secchio carrellato con strizzatore in nylon - 2 secchi da 17 L - maniglione reversibile - ruote multidirezionali da  $\varnothing$  80 mm.

EN Bucket with nylon wringer on wheels - 2x17 L buckets - reversible handle - multidirectional wheels  $\varnothing$  80 mm.

FR Seau sur roue avec essoreuse en nylon - 2 seaux de 17 litres - poignée réversible - roues multidirectionnelles  $\varnothing$  80 mm.

DE Fahrbarer Mopp Eimer mit Nylonpresse - 2x17 L. Eimer - Wendegriff - Mehrwegräder  $\varnothing$  80mm.

	CA 1604
	69 x 42 x 85(h) cm
	170 €

	CA 1604E
	71 x 43 x 93(h) cm
	100 €

+5%

Carrelli per pulizia  
Cleaning trolleys

## CA 1613



IT Carrello per pulizia. Telaio e impugnatura in plastica - secchio, strizzatore e cassette in plastica - strizzatore in plastica a libro senza fondo - portasacco da 120 L completo di rinforzi e coperchio - 2 secchielli da 4 L e 1 secchio da 28 L - gancio portapaletta e gancio portamanico con rullo in gomma.

EN Cleaning trolley Plastic frame and handle - plastic bucket, wringer and trays - plastic wringer without bottom - 120 L bag holder complete with reinforcements and lid - 2x4 L buckets and 1x28 L bucket. - dustpan hook and handle hook with rubber roller.

FR Chariot pour le nettoyage. Corps et poignée en plastique - seau,essoreuse et bacs en plastique -essoreuse en plastique sans fond - porte-sac de 120 L. complet avec renforts et couvercle - 2 seaux de 4 L. et 1 seau de 28 L. - crochet pour palette et manche avec rouleau en caoutchouc.

DE Reinigungswagen. Kunststoffrahmen und -griff - Eimer, Presse und Behälter aus Kunststoff - Kunststoffpresse ohne Boden - 120 L. Sackhalterung komplett mit Verstärkungen und Deckel - 2x4 L. Eimer und 1x28 L. Eimer - Kehrblech- und Griffhaken mit Gummirolle.

## CA 1614





IT Carrello per pulizia. Telaio e impugnatura in plastica - secchio, strizzatore e cassetta in plastica media - portasacco - 2 secchielli da 4 L e 1 secchio da 15 L - ganci portascoppe - ruote ø 100 mm. Il portavascehte superiore non è incluso.

EN Cleaning trolley Plastic frame and handle - bucket, wringer and medium plastic tray - bag holder - 2 buckets of 4 L and 1 bucket of 15 L - broom hook - wheels ø 100 mm. The upper tray holder is not included.

FR Chariot pour le nettoyage. Corps et poignée en plastique - seau,essoreuse et bac moyen en plastique moyenne - porte-sac - 2 seaux de 4 L. et 1 seau de 15 L. - crochets porte balai - roues ø 100 mm. Le porte bacs supérieur n'est pas inclus.

DE Reinigungswagen. Kunststoffrahmen und -griff - Eimer, Presse und mittelgroßer Behälter aus Kunststoff - Sackhalterung - 2x4 L. Eimer und 1x15 L. Eimer - Besenhaken - Räder ø 100 mm. Der obere Ablagefachhalter ist nicht inbegriffen.

	CA 1613
	107 x 56 x 111(h) cm
	320 €

	CA 1614
	92 x 55 x 124(h) cm
	380 €

**+5%**

## CA 1615



IT Carrello per la pulizia. Telaio e impugnatura in plastica - secchio, strizzatore e cassetta in plastica media - portascopo - 2 secchielli da 4 L e 2 secchi da 15 L - ganci portascopo - vano centrale con cassetto scorrevole - ruote ø 100 mm. Portavaschette superiore non incluso.

EN Cleaning trolley Plastic frame and handle - bucket, wringer and medium plastic tray - bag holder - 2x4 L buckets and 2x15 L buckets - broom hook - central compartment with sliding drawer - wheels ø 100 mm. The upper tray holder is not included.

FR Chariot pour le nettoyage. Corps et poignée en plastique - seau, essoreuse et bac moyen en plastique moyenne - porte-sac - 2 seaux de 4 L. et 2 seaux de 15 litres - crochets porte balai - compartiment central avec tiroir coulissant - roues ø 100 mm. Le port bacs supérieur n'est pas inclus.

DE Reinigungswagen. Kunststoffrahmen und -griff - Eimer, Presse und mittelgroßer Behälter aus Kunststoff - Sackhalterung - 2x4 L. Eimer und 1x15 L. Eimer - Besenhaken - Mittelfach mit Schiebeschublade - Räder ø 100 mm. Der obere Ablagefachhalter ist nicht inbegriffen.

## CA 1616





IT Carrello per la pulizia. Telaio e impugnatura in plastica - secchio, strizzatore e cassetta in plastica media - cestino portabottiglie portascopo - 4 secchielli da 4 L e 2 secchi da 15 L - ganci portascopo - vano centrale con cassetto scorrevole - ruote ø 100 mm. Coperchio superiore di colore blu non incluso nel prezzo.

EN Cleaning trolley Plastic frame and handle - bucket, wringer and medium plastic tray - bottle rack - bag holder - 2x4 L buckets and 2x15 L buckets - broom hook - central compartment with sliding drawer - wheels ø 100 mm. Blue lid not included in the price.

FR Chariot pour le nettoyage. Corps et poignée en plastique - seau, essoreuse et bac moyen en plastique moyenne - corbeille pour bouteilles, porte-sac - 4 seaux de 4 L. et 2 seaux de 15 litres - crochets porte balai - compartiment central avec tiroir coulissant - roues ø 100 mm. Couvercle supérieur bleu non compris dans le prix.

DE Reinigungswagen. Kunststoffrahmen und -griff - Eimer, Presse und mittelgroßer Behälter aus Kunststoff - Flaschenkorb und Sackhalterung - 2x4 L. Eimer und 1x15 L. Eimer - Besenhaken - Mittelfach mit Schiebeschublade - Räder ø 100 mm. Blaue obere Abdeckung nicht im Preis inbegriffen.

	CA 1615
	92 x 68 x 124(h) cm
	400 €

	CA 1616
	133 x 68 x 124(h) cm
	640 €

**+5%**

Carrelli per pulizia  
Cleaning trolleys

## CA 1606E



IT Carrello per pulizia. Telaio e impugnatura in plastica - secchio con strizzatore in plastica - portasacco con sacco da 120 L - attacco porta utensili.

EN Cleaning trolley Plastic frame and handle - bucket with plastic wringer - bag holder with 120 L bag - tool holder.

FR Chariot pour le nettoyage. Corps et poignée en plastique - seau avec essoreuse en plastique - porte-sac avec sac de 120 L. - porte-outils.

DE Reinigungswagen. Kunststoffrahmen und -griff - Eimer mit Kunststoffpresse - Sackhalterung mit 120 L. Sack - Werkzeughalteranschluss.

## CA 1520



IT Carrello multiuso in plastica.

EN Multi-purpose plastic trolley.

FR Multi-purpose plastic trolley.

DE Mehrzweckwagen aus Kunststoff.

	CA 1606E
	114 x 51 x 98(h) cm
	200 €

	CA 1520
	150 x 54 x 99(h) cm
	260 €

 Carrelli per pulizia  
Cleaning trolleys

+5%

Carrello multiuso in plastica  
Multi-purpose plastic trolley

forcar®





# Articoli vari per la macelleria

ITEMS FOR THE MEAT PROCESSING  
ARTICLES POUR  
LA TRANSFORMATION DE LA VIANDE  
ARTIKEL FÜR DIE FLEISCHVERARBEITUNG

## LMMC



## LMM



## LM 48M



IT Combinato lavamani più lavastracci in acciaio inox con rubinetto acqua calda/fredda.

EN Stainless steel combi hand washer and rags washer with hot / cold water tap.

FR Lave-mains combiné en acier inox avec robinet d'eau chaude / froide.

DE Handwasch- & Ausgussbecken übereinanderliegend mit Heiß / Kaltwassermischer.

IT Lavamani con mobile e comandi a ginocchio. Lavamani in acciaio inox su mobile con porte a battente - comando a ginocchio.

EN Hand washer on neutral element with knee lever. Stainless steel hand washer on cabinet with hinged doors - knee lever.

FR Lave-mains sur meuble neutre avec commande à genou. Lave-mains en acier inox sur meuble à portes battantes - commande à genou.

DE Handwaschbecken auf Schrank mit Kniehebel. Handwaschbecken auf Schrank mit Flügeltüren - Kniehebel.

	LMMC
	70 x 50 x 89(h) cm
	500 €

	LMM	LM 48M
	50 x 40 x 85(h) cm	40 x 40 x 85(h) cm
	450 €	420 €

**+5%**

Lavamani  
Hand washer

## LC 50MM



## LM 40



## LM 48



## LC 50



IT Lavamani e lavautensili con mobile. Lavamani e utensili su mobile in acciaio inox - porta battente - miscelatore acqua calda/fredda vasca da 40x40x25(h) cm.

EN Hand washer and tools washer on cabinet. Hand washer and tools washer on stainless steel cabinet - hinged door - hot / cold water tap, bowl 40x40x25(h) cm.

FR Lave-mains et lave-outils sur meuble. Lave-mains et lave-outils sur meuble en acier inox - porte battante - robinet d'eau chaude / froide cuve 40x40x25(h) cm.

DE Hand- und Werkzeugwaschbecken auf Schrank. Hand- und Werkzeugwaschbecken auf Edelstahlschrank - Flügeltür - 40x40x25(h) cm Heiß-/Kaltwassermischer.

IT Lavamani a colonna e comandi a ginocchio. Struttura in acciaio inox.

EN Pillar hand washer with knee lever. Stainless steel structure.

FR Colonne lave-mains avec commandes à genou. Structure en acier inox.

DE Säulenhandwaschbecken mit Kniehebel. Edelstahlstruktur.

	LC 50MM
	50 x 50 x 85(h) cm
	550 €

	LM 40	LM 48	LC 50
	40 x 40 x 32(h) cm	48 x 35 x 53(h) cm	50 x 40 x 80(h) cm
	230 €	310 €	330 €

**+5%**



## SUV 10

## SUV 14

## SN 38



IT Armadietto sterilizzante a raggi UV costruito in acciaio inox Scotch Brite. Portina in plexiglas trasparente con microinterruttore - portacoltelli in acciaio inox - funzionamento con lampada germicida con griglia di protezione temporizzatore 60' e lampada spia di funzionamento - cavo con spina.

EN UV sterilizer cabinet made of Scotch Brite stainless steel. Clear Plexiglas door with microswitch - stainless steel knife holder - operation with germicidal lamp with 60' timer protection grid and indicator lamp - cable with plug.

FR Armoire stérilisateur UV en acier inox Scotch Brite. Porte en plexiglas transparent avec microinterrupteur - porte-couteau en acier inox - fonctionnement avec lampe germicide avec grille de protection, minuteur 60' et indicateur lumineux - câble avec fiche.





DE UV-Sterilisationsschrank aus Scotch Brite Edelstahl. Tür aus klarem Plexiglas mit Mikroschalter - Messerhalter aus Edelstahl - Betrieb mit Keimtöterlampe mit 60' Timer, Schutzgitter und Anzeigelampe - Kabel mit Stecker.

IT Sterilizzatori elettrici per coltelli. Struttura in acciaio inox - termostato regolabile interno +30 +110°C - rubinetto di carico e scarico.

EN Electric knives sterilizers Stainless steel structure - internal adjustable thermostat +30 +110°C - filling and emptying tap.

FR Stérilisateur électriques pour couteaux. Structure en acier inox - thermostat interne réglable +30 +110°C - robinet de remplissage et de vidange.

DE Elektrische Sterilisatoren für Messer. Edelstahlstruktur - innenliegender einstellbarer Thermostat +30 +110°C - Be- und Entladehahn.

	SUV 10	SUV 14
	16 W	
 1 Ph	230 V 50/60 HZ	
	N° 10 coltelli - knives	N° 14 coltelli - knives
 cm	43 x 16 x 64(h) cm	54 x 16 x 64(h) cm
	270 €	290 €

	SN 38
	1500 W
 1 Ph	230 V 50/60 HZ
	N° 12 coltelli - knives
 cm	38 x 14 x 40(h) cm
	300 €

+5%

Sterilizzatori  
Sterilizers

# ANTINFORTUNISTICA PER MACELLERIA

AV 4897 - AV 4898 - AV 4899  
AV 4900 - AV 4901

<b>i</b>	AV 4897
1	<p>Grembiule alluminio antinfortunistico con bretelle Aluminium safety apron with shoulder straps Tablier de sécurité en aluminium avec sangles d'épaule Aluminium Sicherheitsschürze mit Schultergurten</p>
	155 €

<b>i</b>	AV4900
4	<p>Guanto inox antinfortunistico a cinque dita con cinturino inox completamente sterilizzabile Five-finger stainless steel safety glove with stainless steel strap, fully sterilisable Gant de sécurité à cinq doigts en acier inox avec sangle en acier inox, entièrement stérilisable Edelstahl-Fünf-Finger-Sicherheitshandschuh mit Edelstahlband völlig sterilisierbar</p>
	150 €

<b>i</b>	AV 4898
2	<p>Grembiule acciaio inox antinfortunistico con bretelle Stainless steel safety apron with shoulder straps Tablier de sécurité en acier inox avec sangles d'épaule Edelstahl-Sicherheitsschürze mit Schultergurten</p>
	180 €

<b>i</b>	AV4901
5	<p>Guanto inox antinfortunistico a cinque dita con chiusura a molla inox. Avambraccio compreso Stainless steel five finger safety glove with stainless steel spring fastening. Forearm included. Gant de sécurité à cinq doigts en acier inox avec fermeture à ressort en acier inox. Avant-bras inclus. Edelstahl-Fünf-Finger-Sicherheitshandschuh mit Edelstahl-Feder-Verschluss. Unterarm inklusive.</p>
	270 €

<b>i</b>	AV 4899
3	<p>Avambraccio antinfortunistico in plexiglass misura standard Safety Plexiglas forearm standard size Avant-bras de protection en plexiglas taille standard Unterarmschutz aus Plexiglas, Standardgröße</p>
	40 €

+5%



# CCL

IT Ceppo in legno di acacia e sgabello. Ceppo trattato con vernice atossica e collanti ecologici (conformi alle norme vigenti) assemblato con innesti a pressione e internamente con inserti speciali in legno - batticarne ecologico e riciclabile - reversibile.

EN Acacia wood chopping block and stool. Chopping block treated with non-toxic paint and ecological adhesives (in compliance with current standards) assembled with pressure joints and internally with special wood inserts - ecological and recyclable meat beater - reversible.

FR Blocs de boucher en bois d'acacia et tabouret. Bloc traité avec peinture atoxique et adhésifs écologiques (conformes aux normes en vigueur) assemblés avec embrayages à pression et intérieur avec inserts spéciaux en bois - bloc à viande écologique et recyclable - réversible.

DE Metzger-Block aus Akazienholz und Hocker. Metzger-Block behandelt mit ungiftiger Farbe und ökologischen Klebstoffen (nach den gültigen Normen), zusammengebaut mit Steckverbindungen und speziellen innen Holzeinsätzen - umweltfreundlicher und wiederverwertbarer Fleischklopper - beidseitig.



	CCL 1744	CCL 1745	CCL 1755	CCL 1764	CCL 1766	CCL 1774	CCL 1775
	40 x 40 x 90(h) cm	45 x 45 x 90(h) cm	50 x 50 x 90(h) cm	60 x 40 x 90(h) cm	60 x 60 x 90(h) cm	70 x 40 x 90(h) cm	70 x 50 x 90(h) cm
	400 €	450 €	530 €	530 €	700 €	585 €	700 €



SPESSORE / THICKNESS 17 cm

	CCL 2544	CCL 2555	CCL 2564	CCL 2566	CCL 2574	CCL 2575	CCL 2577
	40 x 40 x 90(h) cm	50 x 50 x 90(h) cm	60 x 40 x 90(h) cm	60 x 60 x 90(h) cm	70 x 40 x 90(h) cm	70 x 50 x 90(h) cm	70 x 70 x 90(h) cm
	505 €	660 €	660 €	810 €	700 €	810 €	960 €



SPESSORE / THICKNESS 25 cm

	CCL 3555	CCL 3566	CCL 3575	CCL 3577	CCL 3586
	50 x 50 x 90(h) cm	60 x 60 x 90(h) cm	70 x 50 x 90(h) cm	70 x 70 x 90(h) cm	80 x 60 x 90(h) cm
	810 €	1000 €	1000 €	1250 €	1250 €



SPESSORE / THICKNESS 35 cm

Ceppi  
Butcher blocks

## CCP

IT Ceppo in polietilene e sgabello in acciaio inox **AISI 304**. Per ceppi, sgabelli o misure speciali, richiedere preventivo.

EN Polyethylene block and **AISI 304** stainless steel stool. For chopping blocks, stools or special sizes, please ask for a quote.

FR Bloc en polyéthylène et tabouret en acier inox **AISI 304**. Pour blocs, tabourets ou dimensions spéciales, contactez-nous pour une offre.

DE Polyethylenblock und Hocker aus Edelstahl **AISI 304**. Für Metzger-Blöcke, Hocker oder Sondergrößen bitte ein Angebot anfordern.



	CCP 8000	CCP 8001	CCP 8002	CCP 8003
	40 x 40 x 88(h) cm	50 x 50 x 88(h) cm	70 x 50 x 88(h) cm	60 x 60 x 88(h) cm
	360 €	455 €	545 €	530 €

	CCP 8004	CCP 8005	CCP 8006
	70 x 70 x 88(h) cm	80 x 60 x 88(h) cm	100 x 50 x 88(h) cm
	680 €	630 €	670 €

+5%

## KCP

IT Copriceppo di polietilene bianco.

EN White polyethylene block cover.

FR Couverture en polyéthylène blanc.

DE Weiße Polyethylenabdeckung.



	KCP 2501	KCP 2502	KCP 2503	KCP 2504
	40 x 40 x 2,5(h) cm	50 x 50 x 2,5(h) cm	60 x 40 x 2,5(h) cm	60 x 60 x 2,5(h) cm
	75 €	100 €	95 €	125 €

	KCP 2505	KCP 2506	KCP 2508
	70 x 40 x 2,5(h) cm	70 x 50 x 2,5(h) cm	70 x 70 x 2,5(h) cm
	110 €	130 €	160 €

+5%

## CPE

IT Copriceppo di polietilene alimentare bianco.

EN Chopping block cover made of white food grade polyethylene.

FR Couverture blanche en polyéthylène alimentaire.

DE Weiße Abdeckung aus lebensmitteltauglichem Polyeliten.



	CPE 40408	CPE 50508	CPE 70508	CPE 60608
	40 x 40 x 8(h) cm	50 x 50 x 8(h) cm	70 x 50 x 8(h) cm	60 x 60 x 8(h) cm
	150 €	230 €	310 €	290 €

	CPE 70708	CPE 80608	CPE 100508
	70 x 70 x 8(h) cm	80 x 60 x 8(h) cm	100 x 50 x 8(h) cm
	390 €	380 €	390 €

# TP

IT Taglieri in polietilene. Colore bianco.

EN Polyethylene cutting boards. Colour: white.

FR Planches à découper en polyéthylène. Couleur blanche.

DE Schneidbretter aus Polyethylen. Farbe: weiß.



GIALLO/YELLOW



MARRONE/BROWN



VERDE/GREEN



BLU/BLUE



ROSSO/RED

Per scelta colore aggiungere al codice:

For colour choice add to code:

Pour choisir la couleur, ajoutez au code:

Fügen Sie für die Farbauswahl den Code hinzu:

Y = Giallo / Yellow / Gelb / Jaune

M = Marrone / Brown / Braun / Marron

G = Verde / Green / Grün / Vert

B = Blu / Blue / Blau / Bleu

R = Rosso / Red / Rot / Rouge

# RASK - RICRA

IT **RASK:** Raschietto per pulizia ceppi e taglieri.

**RICRA:** Ricambio lama per raschietto

EN **RASK:** Scraper for butcher blocks and cutting boards cleaning.

**RICRA:** Spare blade for scraper

FR **RASK:** Racloir pour le nettoyage des blocs et des planches à découper.

**RICRA:** Lame de rechange pour racloir

DE **RASK:** Schaber zum Reinigen von Metzger-Blöcke und Schneidbrettern.

**RICRA:** Ersatzklinge für Schaber.



RASK

	RASK	RICRA
	30 €	14 €

	TP 40302	TP 50302	TP 50402	TP 60402
	40 x 30 x 2(h) cm	50 x 30 x 2(h) cm	50 x 40 x 2(h) cm	60 x 40 x 2(h) cm
	25 €	29 €	39 €	47 €

	TP 70402	TP 80402	TP 50302	TP 60402
	70 x 40 x 2(h) cm	80 x 40 x 2(h) cm	50 x 30 x 2(h) cm Y/M/G/B/R	60 x 40 x 2(h) cm Y/M/G/B/R
	55 €	61 €	31 €	50 €

+5%

Taglieri e raschietto  
Cutting boards and scraper

# Scaffalatura modulare

## Modular shelving



IT Scaffalatura modulare in alluminio anodizzato. Design rispondente alle norme igieniche con superfici lisce ed arrotondate, profili chiusi e totale assenza di spazi o fessure - leghe di alta qualità resistenti all'usura prodotta da agenti chimici, termici e meccanici - ampia scelta di misure - possibilità di inserimento vaschette serie Gastronorm GN1/2-GN1/1-GN2/1-GN2/3 inserite all'interno dei ripiani.

EN Modular shelving in anodized aluminium. Design in compliance with hygiene standards with smooth and rounded surfaces, closed profiles and total absence of spaces or gaps - high quality alloys resistant to wear produced by chemical, thermal and mechanical agents - wide choice of sizes - possibility of inserting Gastronorm containers GN1/2-GN1/1-GN2/1-GN2/3 inside the shelves.

FR Rayonnage modulaire en aluminium anodisé. Design hygiénique avec des surfaces lisses et arrondies, des profilés fermés et absence totale d'espaces ou de fissures - alliages de haute qualité résistants à l'usure par des agents chimiques, thermiques et mécaniques - large choix de dimensions - possibilité d'insérer des bacs Gastronorm GN1/2-GN1/1-GN2/1-GN2/3 dans les étagères.

DE Modulare Regale aus eloxiertem Aluminium. Design nach Hygienestandards mit glatten und abgerundeten Oberflächen, geschlossenen Profilen und völliger Abwesenheit von Zwischenräumen oder Rissen - hochwertige, verschleißfeste Legierungen gegen chemischen, thermischen und mechanischen Werkstoffen - umfangreiche Größenauswahl - Behältern der Serie Gastronorm GN1/2-GN1/1-GN2/1-GN2/1-GN2/3, in den Regalen einsetzbar.

IT Ripiani in alluminio completi di griglie in polietilene. Composti da: 2 fiancate, 4 attacchi, serie griglie.

EN Aluminium shelves complete with polyethylene grids. Composed of: 2 sides, 4 brackets, grids.

FR Étagères en aluminium complètes avec des grilles en polyéthylène. Composé de: 2 côtés, 4 supports, série de grilles.

DE Aluminiumzwischenetagen komplett mit Polyethylen-Gittern. Bestehend aus: 2 Seitenpaneele, 4 Halterungen, Gittern.

i	R62	R88	R97	R106
	Max. 240 kg	Max. 180 kg	Max. 170 kg	Max. 150 kg
↗ cm	37,3 x 62(h) cm	37,3 x 88,6(h) cm	37,3 x 97,4(h) cm	37,3 x 106,2(h) cm
	45 €	54 €	57 €	60 €

i	R115	R124	R133	R150
	Max. 140 kg	Max. 130 kg	Max. 110 kg	Max. 90 kg
↗ cm	37,3 x 115,2(h) cm	37,3 x 124(h) cm	37,3 x 133(h) cm	37,3 x 150,5(h) cm
	66 €	69 €	78 €	80 €

IT Testata in alluminio completa di: 2 piantane, 3 traversini, 2 piedi e 2 tappi.

EN Aluminium front panel. Complete with: 2 pillars, 3 crosspieces, 2 feet and 2 plugs.

FR Façade en aluminium. Complète avec: 2 montants, 3 traverses, 2 pieds et 2 capuchons.

DE Edelstahlfrontblende. Komplett mit: 2 Träger, 3 Querstäbe, 2 Füße und 2 Kappen.



Giunzioni per angolo.  
Corner joints.  
Joints de coin.  
Eckverbindungen.

i	F15	F17	F20	GA373
↗ cm	37,3 x 155(h) cm	37,3 x 170(h) cm	37,3 x 200(h) cm	37,3 cm
	76 €	78 €	84 €	20 €

# SE30



# FT30

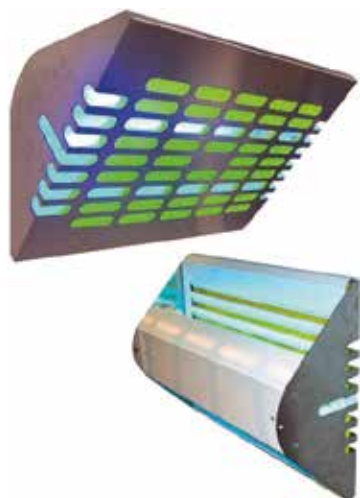

# PZ30



IT Elettroinsetticidi a lampade UVA. Materiale alluminio. Potenza 30W.  
Lampade 2x15W - possibilità di montaggio in orizzontale o verticale -  
copertura fino a 80 mq.

EN Electro-insecticides with UVA lamps. Material: Aluminium Power 30W.  
2x15W lamps - horizontal or vertical installation - surface cover up to 80  
sqm.

FR Electro-insecticides avec lampes UVA. Matériel : aluminium. Puissance 30W.  
2 Lampes 15W - possibilité de montage horizontal ou vertical - portée ju-  
squ'à 80 m².

DE Elektroinsekt-Killer mit UVA-Lampen. Material: Aluminium. Leistung 30W.  
2x15W Lampen - horizontale oder vertikale Montage möglich - Reichweite  
bis zu 80 qm.

	SE30	FT30	PZ30
	32 x 14 x 54(h) cm	48 x 36 x 16(h) cm	52 x 13 x 26(h) cm
	210 €	220 €	100 €

## Optional

CRS30 SE30	CR30 FT30
Collante di ricambio confezione da 6 pezzi Spare glue pack of 6 pieces Colle de rechange 6 pièces Ersatzkleber 6 Stück-Packung	
34 €	45 €
L617 PZ30-FT30-SE30	
Lampada da 15 W 15 W lamp Lampe 15 W 15 W Lampe	
10 €	

**+5%**

Elettroinsetticidi  
Electro-insecticides



# Attrezzatura per la colazione

BREAKFAST EQUIPMENT  
ÉQUIPEMENT DE PETIT-DÉJEUNER  
FRÜHSTÜCKSAUSRÜSTUNG



## CD 7905



IT Chafing dish con coperchio. Struttura rettangolare in acciaio inox - bruciatori ad alcool.

EN Chafing dish with lid. Rectangular stainless steel casing - alcohol burners.

FR Chafing Dish avec couvercle. Corps rectangulaire en acier inox - Brûleurs à alcool.

DE Chafing Dish mit Deckel. Rechteckige Edelstahlstruktur - Alkohol-Brenner.

## CD 9801



IT Chafing dish con coperchio roll top. Struttura in acciaio inox lucido - bruciatori ad alcool.

EN Chafing dish with roll top lid. Rectangular polished stainless steel casing - alcohol burners.

FR Chafing Dish avec couvercle supérieur roll top. Corps rectangulaire en acier inox poli - Brûleurs à alcool.

DE Chafing Dish mit Roll-Top Deckel. Rechteckige polierte Edelstahlstruktur - Alkohol-Brenner.

	CD 7905
	67 x 37 x 41(h) cm
	100 €

	CD 9801
	65 x 47 x 45(h) cm
	238 €

+5%

## CD 6502



IT Chafing dish con coperchio roll top 180°. Struttura in acciaio inox lucido - bruciatori ad alcool.

EN Chafing dish with roll top lid 180°. Rectangular polished stainless steel casing - alcohol burners.

FR Chafing Dish avec couvercle supérieur roll top 180°. Corps rectangulaire en acier inox poli - Brûleurs à alcool.

DE Chafing Dish mit 180° Roll-Top Deckel. Rechteckige polierte Edelstahlstruktur - Alkohol-Brenner.

## CD 6504



IT Chafing dish tondo con coperchio roll top 180°. Struttura in acciaio inox lucido - bruciatori ad alcool.

EN Round Chafing dish with roll top lid 180°. Rectangular polished stainless steel casing - alcohol burners.

FR Chafing Dish ronde avec couvercle supérieur roll top 180°. Corps rectangulaire en acier inox poli - Brûleurs à alcool.

DE Rundes Chafing Dish mit 180° Roll-Top Deckel. Rechteckige polierte Edelstahlstruktur - Alkohol-Brenner.

	CD 6502
	65 x 47 x 45 (h) cm
	430 €

	CD 6504
	50 x 52 x 45 (h) cm
	395 €

**+5%**

# CD 6505



- IT Chafing dish con coperchio roll top 180° e pentole da 4,6 L Struttura in acciaio inox lucido - bruciatori ad alcool.
- EN Chafing dish with roll top lid 180° and 4,6 L pans. Rectangular polished stainless steel casing - alcohol burners.
- FR Chafing Dish avec couvercle supérieur roll top 180° t marmites de 4,6 L. Corps rectangulaire en acier inox poli - Brûleurs à alcool.
- DE Chafing Dish mit 180° Roll-Top Deckel und 4,6 L. Töpfe. Rechteckige polierte Edelstahlstruktur - Alkohol-Brenner.

	CD 6505
	65 x 47 x 45 (h) cm
	500 €

**+5%**

## Optional

AV9516

CD 7905 - CD 9801 - CD 6502 - CD 6504 - CD 6505

Elemento di riscaldamento elettrico per Chafing Dishes 230 V 50/60 Hz 360 W.

Electric heating element for Chafing Dishes 230 V 50/60 Hz 360 W.

Élément électrique de chauffage pour Chafing Dishes 230 V 50/60 Hz 360 W.

Elektrischer Heizelement für Chafing Dishes 230 V 50/60 Hz 360 W.

100 €

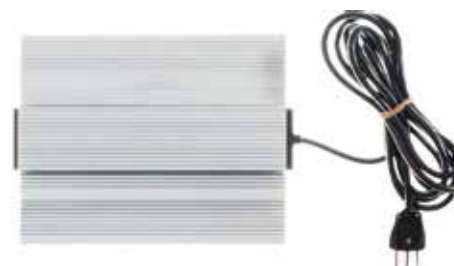

AV9517  
DC10502

Elemento elettrico riscaldante 180 W. Per DC 10502

Electric heating element 180 W. For DC 10502

Élément électrique chauffant 180 W. Pour DC 10502

Elektrischer Heizelement 180 W. Für DC 10502

88 €



## B 8001



## DC 10502



IT Zuppiera elettrica. Corpo in alluminio verniciato - contenitore e coperchio in acciaio inox.

EN Electric soup tureen Painted aluminium casing - stainless steel container and lid.

FR Soupière électrique. Corps en aluminium peint - récipient et couvercle en acier inox.

DE Elektrische Terrine. Gehäuse aus lackiertem Aluminium - Behälter und Deckel aus Edelstahl.

IT Distributore caldo per caffè. Struttura in acciaio inox - bruciatore ad alcool.

EN Hot coffee dispenser. Stainless steel casing - alcohol burner.

FR Distributeur de café chaud. Corps en acier inox poli - Brûleurs à alcool.

DE Heißkaffeespender. Gehäuse aus Edelstahl - Alkohol-Brenner.

	B 8001
	230 V - 360 W
	ø 35 x 36(h) cm
	10 L
	220 €

+5%

	DC 10502
	33 x 24 x 54(h) cm
	9 L
	270 €

## DCN 1706



IT Distributore caldo per caffè. Struttura in ABS con copertura in acciaio inox - dotato di termica di sicurezza - temperatura 90°C.

EN Hot coffee dispenser. ABS structure with stainless steel cover - equipped with safety thermic - temperature 90 ° C.

FR Distributeur de café chaud. Corps en ABS avec couvercle en acier inox - équipée d'un thermique de sécurité - température 90°C.

DE Heißkaffespender. ABS-Gehäuse mit Edelstahlabdeckung - ausgestattet mit Sicherheitsthermik - Temperatur 90 ° C

## DS 10401



IT Distributore bevande. Contenitore trasparente - tubo centrale per contenimento ghiaccio.

EN Beverage dispenser. Clear container - central tube for ice filling.

FR Distributeur de boissons. Récipient transparent - tube central pour contenir de la glace.

DE Getränkespender. Klarer Behälter - Zentralrohr für die Eiseinführung.

## DS 10402



	DCN 1706
	230 V - 1100 W
	ø 29 x 44(h) cm
	7 L (40 tazzine - cup)
	160 €

**+5%**

	DS 10401	DS 10402
	27 x 22 x 58(h) cm	32 x 32 x 58(h) cm
	8 L	5 + 5 L
	215 €	410 €

# DC 10301

# DC 10302



IT Distributore per cereali. Contenitori trasparenti, singoli o doppi.

EN Cereals dispenser. Clear containers, single or double.

FR Distributeur de céréales. Récipients transparents, simples ou doubles.

DE Müslispender. Transparente Behälter, einfach oder doppelt.

**+5%**

<b>i</b>	DC 10301	DC 10302
<b>cm</b>	36 x 26 x 66(h) cm	48 x 26 x 66(h) cm
<b>L</b>	8 L	8 + 8 L
	175 €	330 €

# AV 4561

IT Fornello flambé a gas in rame con griglia in acciaio inox.

EN Copper gas flambé cooker with stainless steel grid.

FR Cuisinière flambée à gaz en cuivre avec grille en acier inox.

DE Flambé Gasherd aus Kupfer mit Edelstahlgitter.



<b>i</b>	AV 4561
<b>cm</b>	ø 26 x 29,5(h) cm
	325 €

Fornello Flambé  
Flambé cooker

**+5%**

# AV 4580 - AV 4581

IT Padella flambé inox-cuprum, manico legno.

EN Flambé pan stainless steel-cuprum, wooden handle.

FR Poêle flambée en acier inox-cuprum, manche en bois.

DE Flambé Cuprum-Pfanne aus Edelstahl mit Holzgriff.



<b>i</b>	AV 4580	AV 4581
<b>cm</b>	ø 29 cm	ø 26 cm
	130 €	120 €

Padella Flambé  
Flambé pan











# Articoli vari

per cucina e pizzeria



ITEMS FOR COOKING AND PIZZERIA  
ARTICLES POUR LA CUISINE  
ET POUR LA PIZZERIA  
KÜCHE- UND PIZZERIA-ARTIKEL





BACINELLE - CONTAINERS BASSINES - BEHÄLTER					
<b>MOD. 2/1</b> Est. 646 x 530 mm Int. 620 x 500 mm 	GNI 21200	20(h) cm	60 L	<b>96 €</b>	
	GNI 21150	15(h) cm	44,9 L	<b>82 €</b>	
	GNI 21100	10(h) cm	31,5 L	<b>60 €</b>	
	GNI 2165	6,5(h) cm	18,9 L	<b>48 €</b>	
	GNI 2140	4(h) cm	12 L	<b>43 €</b>	
	GNI 2120	2(h) cm	6,5 L	<b>39 €</b>	
	GRI 21	Griglia - Grill		<b>36 €</b>	
<b>MOD. 1/1</b> Est. 530 x 325 mm Int. 500 x 300 mm 	GNI 11200	20(h) cm	30 L	<b>50 €</b>	
	GNI 11150	15(h) cm	20,6 L	<b>42 €</b>	
	GNI 11100	10(h) cm	13,3 L	<b>30 €</b>	
	GNI 1165	6,5(h) cm	8,5 L	<b>24 €</b>	
	GNI 1140	4(h) cm	5,5 L	<b>21 €</b>	
	GNI 1120	2(h) cm	2,5 L	<b>18 €</b>	
	COPI 11	Coperchio Lid		<b>16 €</b>	
	COPG 11	Coperchio a tenuta Leak-proof lid		<b>51 €</b>	
	FFF 11	Falso fondo forato Perforated false bottom		<b>19 €</b>	
	GRI 11	Griglia - Grill		<b>26 €</b>	
	S 530	Separatore Divider		<b>6 €</b>	
<b>MOD. 2/3</b> Est. 352 x 325 mm Int. 329 x 300 mm 	GNI 23200	20(h) cm	19,3 L	<b>36 €</b>	
	GNI 23150	15(h) cm	13,6 L	<b>30 €</b>	
	GNI 23100	10(h) cm	8,9 L	<b>24 €</b>	
	GNI 2365	6,5(h) cm	5,5 L	<b>18 €</b>	
	GNI 2340	4(h) cm	3,5 L	<b>16 €</b>	
	GNI 2320	2(h) cm	1,8 L	<b>12 €</b>	
	COPI 23	Coperchio Lid		<b>13 €</b>	
	COPG 23	Coperchio a tenuta Leak-proof lid		<b>39 €</b>	
	FFF 23	Falso fondo forato Perforated false bottom		<b>16 €</b>	
	GRI 23	Griglia - Grill		<b>21 €</b>	

**+5%**

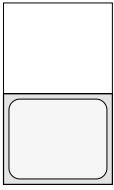
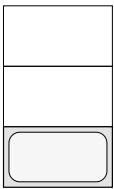
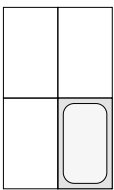

BACINELLE - CONTAINERS BASSINES - BEHÄLTER					
<b>MOD. 1/2</b> Est. 325 x 265 Int. 300 x 238 	GNI 12200	20(h) cm	11,6 L	<b>30 €</b>	
	GNI 12150	15(h) cm	9,9 L	<b>24 €</b>	
	GNI 12100	10(h) cm	8 L	<b>19 €</b>	
	GNI 1265	6,5(h) cm	4,2 L	<b>15 €</b>	
	GNI 1240	4(h) cm	2,5 L	<b>12 €</b>	
	GNI 1220	2(h) cm	1,2 L	<b>10 €</b>	
	COPI 12	Coperchio Lid		<b>10 €</b>	
	COPG 12	Coperchio a tenuta Leak-proof lid		<b>36 €</b>	
	FFF 12	Falso fondo forato Perforated false bottom		<b>11 €</b>	
	S 325	Separatore Divider		<b>5 €</b>	
<b>MOD. 1/3</b> Est. 325 x 176 Int. 300 x 150 	GNI 13200	20(h) cm	8,1 L	<b>23 €</b>	
	GNI 13150	15(h) cm	5,9 L	<b>20 €</b>	
	GNI 13100	10(h) cm	3,8 L	<b>15 €</b>	
	GNI 1365	6,5(h) cm	2,5 L	<b>12 €</b>	
	GNI 1340	4(h) cm	1,5 L	<b>10 €</b>	
	GNI 1320	2(h) cm	0,7 L	<b>7 €</b>	
	COPI 13	Coperchio Lid		<b>8 €</b>	
	COPG 13	Coperchio a tenuta Leak-proof lid		<b>31 €</b>	
FFF 13	Falso fondo forato Perforated false bottom		<b>9 €</b>		
<b>MOD. 1/4</b> Est. 265 x 162 INT. 238 x 136 	GNI 14200	20(h) cm	4,9 L	<b>21 €</b>	
	GNI 14150	15(h) cm	4,1 L	<b>16 €</b>	
	GNI 14100	10(h) cm	2,5 L	<b>14 €</b>	
	GNI 1465	6,5(h) cm	1,9 L	<b>10 €</b>	
	GNI 1440	4(h) cm	1 L	<b>8 €</b>	
	GNI 1420	2(h) cm	0,5 L	<b>7 €</b>	
	COPI 14	Coperchio Lid		<b>7 €</b>	
	COPG 14	Coperchio a tenuta Leak-proof lid		<b>26 €</b>	
	S 265	Separatore Divider		<b>5 €</b>	

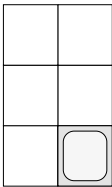
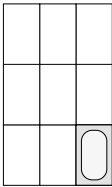

BACINELLE - CONTAINERS BASSINES - BEHÄLTER					
<b>MOD. 1/6</b> Est. 176 x 162 Int. 140 x 153		GNI 16200	20(h) cm	3 L	25 €
		GNI 16150	15(h) cm	2,5 L	15 €
		GNI 16100	10(h) cm	1,6 L	12 €
		GNI 1665	6,5(h) cm	1,1 L	10 €
		COPI 16	Coperchio Lid		6 €
		COPG 16	Coperchio a tenuta Leak-proof lid		25 €
<b>MOD. 1/9</b> Est. 176 x 108 Int. 140 x 100		GNI 19100	10(h) cm	0,9 L	12 €
		GNI 1965	6,5(h) cm	0,5 L	9 €
		COPI 19	Coperchio Lid		5 €









**ATTENZIONE** i coperchi a tenuta possono essere applicati solo su bacinelle GN con H mm. 100, 150 e 200

**ATTENTION** the leak-proof lids can only be applied to GN basins with H 100, 150 and 200 mm.



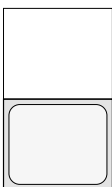

**ATTENTION** les couvercles anti-fuite ne peuvent être appliqués que sur des bassines GN avec H 100, 150 et 200 mm.

**ACHTUNG** Die versiegelten Deckel können nur bei GN-Behältern mit H 100, 150 und 200mm eingesetzt werden.



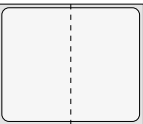

BACINELLE FORATE - PIERCED BASINS CUVETTES PERCÉES - LOCHSCHALE					
<b>MOD. 2/1</b> Est. 646 x 530 mm Int. 620 x 500 mm		GNT 21200	20(h) cm	60 L	156 €
		GNT 21150	15(h) cm	44,9 L	110 €
		GNT 21100	10(h) cm	31,5 L	80 €
		GNT 2165	6,5(h) cm	18,9 L	78 €
<b>MOD. 1/1</b> Est. 530 x 325 Int. 500 x 300		GNT 11200	20(h) cm	30 L	66 €
		GNT 11150	15(h) cm	20,6 L	50 €
		GNT 11100	10(h) cm	13,3 L	40 €
		GNT 1165	6,5(h) cm	8,5 L	30 €
<b>MOD. 2/3</b> Est. 352 x 325 Int. 329 x 300		GNT 23200	20(h) cm	19,3 L	40 €
		GNT 23150	15(h) cm	13,6 L	35 €
		GNT 23100	10(h) cm	8,9 L	32 €
		GNT 2365	6,5(h) cm	5,5 L	29 €
<b>MOD. 1/2</b> Est. 325 x 265 Int. 300 x 238		GNT 12200	20(h) cm	11,6 L	42 €
		GNT 12150	15(h) cm	9,9 L	33 €
		GNT 12100	10(h) cm	8 L	29 €
		GNT 1265	6,5(h) cm	4,2 L	19 €

+5%





TEGLIE CON FONDO FORATO TRAYS WITH PERFORATED BOTTOM					
<b>MOD. 2/1</b> Est. 646 x 530 mm Int. 620 x 500 mm		GNF 2120	2(h) cm	6,5 L	41 €
		GNF 2140	4(h) cm	12 L	45 €
		GNF 2165	6,5(h) cm	18,9 L	54 €
<b>MOD. 1/1</b> Est. 530 x 325 Int. 500 x 300		GNF 1120	2(h) cm	2,5 L	20 €
		GNF 1140	4(h) cm	5,5 L	22 €
		GNF 1165	6,5(h) cm	8,5 L	26 €
<b>MOD. 2/3</b> Est. 352 x 325 Int. 329 x 300		GNF 2320	2(h) cm	1,8 L	15 €
		GNF 2340	4(h) cm	3,5 L	18 €
		GNF 2365	6,5(h) cm	5,5 L	20 €
<b>MOD. 1/2</b> Est. 325 x 265 Int. 300 x 238		GNF 1220	2(h) cm	1,2 L	12 €
		GNF 1240	4(h) cm	2,5 L	14 €
		GNF 1265	6,5(h) cm	4,2 L	16 €





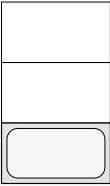
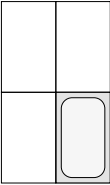
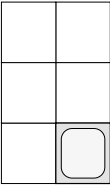
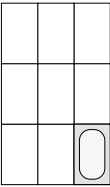

BACINELLE GN IN POLICARBONATO GN POLYCARBONATE CONTAINERS					
<b>MOD. 1/1</b> Est. 530 x 325 Int. 500 x 300		GNP 11200	20(h) cm	30 L	25 €
		GNP 11150	15(h) cm	20,6 L	21 €
		GNP 11100	10(h) cm	13,3 L	17 €
		GNP 1165	6,5(h) cm	8,5 L	14 €
		COPP 11	53 x 32,5 cm	-	10 €
		GFP 11	46 x 25,5 cm	-	8 €
<b>MOD. 1/2</b> Est. 325 x 265 Int. 300 x 238		GNP 12200	20(h) cm	11,6 L	15 €
		GNP 12150	15(h) cm	9,9 L	13 €
		GNP 12100	10(h) cm	8 L	10 €
		GNP 1265	6,5(h) cm	4,2 L	8 €
		COPP 12	32,5 x 26,5 cm	-	7 €
		GFP 12	25 x 19 cm	-	5 €

**+5%**



BACINELLE GN IN POLICARBONATO GN POLYCARBONATE CONTAINERS					
<b>MOD. 1/3</b> Est. 325 x 176 Int. 300 x 150		GNP 13200	20(h) cm	8,1 L	<b>12 €</b>
		GNP 13150	15(h) cm	5,9 L	<b>10 €</b>
		GNP 13100	10(h) cm	3,8 L	<b>8 €</b>
		GNP 1365	6,5(h) cm	2,5 L	<b>6 €</b>
		COPP 13	32,5 x 17,6 cm	-	<b>5 €</b>
		GFP 13	25 x 11 cm	-	<b>3 €</b>
<b>MOD. 1/4</b> Est. 265 x 162 INT. 238 x 136		GNP 14200	20(h) cm	4,9 L	<b>11 €</b>
		GNP 14150	15(h) cm	4,1 L	<b>8 €</b>
		GNP 14100	10(h) cm	2,5 L	<b>6 €</b>
		GNP 1465	6,5(h) cm	1,9 L	<b>5 €</b>
		COPP 14	26,5 x 16,2 cm	-	<b>3 €</b>
		GFP 14	21 x 11 cm	-	<b>3 €</b>
<b>MOD. 1/6</b> Est. 176 x 162 Int. 140 x 153		GNP 16200	20(h) cm	3 L	<b>8 €</b>
		GNP 16150	15(h) cm	2,5 L	<b>6 €</b>
		GNP 16100	10(h) cm	1,6 L	<b>5 €</b>
		GNP 1665	6,5(h) cm	1,1 L	<b>4 €</b>
		COPP 16	17,6 x 16,2 cm	-	<b>3 €</b>
		GFP 16	11,5 x 10 cm	-	<b>2 €</b>
<b>MOD. 1/9</b> Est. 176 x 108 Int. 140 x 100		GNP 19100	10(h) cm	0,9 L	<b>4 €</b>
		GNP 1965	6,5(h) cm	0,5 L	<b>3 €</b>
		COPP 19	17,6 x 10 cm	-	<b>3 €</b>



**+5%**



VASCHE PER GELATO ICE CREAM CONTAINERS				
	VG 261612	26 x 16,5 x 12(h) cm	3,5 L	20 €
	VG 261615	26 x 16,5 x 15(h) cm	4,1 L	23 €
	VG 33168	33 x 16,5 x 8(h) cm	3,5 L	20 €
	VG 331612	33 x 16,5 x 12(h) cm	5 L	23 €
	VG 331615	33 x 16,5 x 15(h) cm	6,5 L	25 €
	VG 36168	36 x 16,5 x 8(h) cm	3,8 L	19 €
	VG 361612	36 x 16,5 x 12(h) cm	5,4 L	19 €
	VG 361615	36 x 16,5 x 15(h) cm	7,1 L	23 €
	VG 361618	36 x 16,5 x 18(h) cm	8,8 L	26 €
	VG 36258	36 x 25 x 8(h) cm	5 L	21 €
	VG 362512	36 x 25 x 12(h) cm	8 L	22 €
	CR ø 200 H 250	Pozzetto inox per gelato Stainless steel ice-cream bowl		

**+5%**



TEGLIE SMALTATE ENAMELLED TRAYS GN1/1			
	GNS 1120	GN1/1 20(h) cm	24 €
	GNS 1140	GN1/1 40(h) cm	26 €
	GNS 1165	GN1/1 65(h) cm	28 €

COPERCHI IN PLASTICA PLASTIC LIDS			
	CP 2	26,5 x 16 cm	8 €
	CP 3	33 x 16,5 cm	8,5 €
	CP 4	36 x 16,5 cm	9 €

SPATOLA - SPATULA			
	SPG	trasparente, rossa, blu, gialla Manico 26 cm.a	9 €
		Clear, red, blue, yellow Handle 26 cm	

**+5%**

## AV4510



- IT Morsa per prosciutto. Corpo in acciaio inox - supporto e manici in legno pregiato.
- EN Ham stand. Stainless steel structure - support and handles in fine wood.
- FR Serre-jambon. Corps en acier inox - support et poignées en bois de haute qualité.
- DE Schinkengriff. Edelstahlkörper - Stütze und Griffe aus edlem Holz.

	AV4510
	58 x 25 x 19(h) cm
	140 €

+5%

## AV4515



- IT Morsa per prosciutto. Corpo in acciaio - supporto e manici in legno.
- EN Ham stand. Stainless steel structure - support and handles in fine wood.
- FR Serre-jambon. Corps en acier - support et poignées en bois.
- DE Schinkengriff. Edelstahlkörper - Stütze und Griffe aus edlem Holz.

	AV4515
	58 x 25 x 19(h) cm
	45 €

## AV4500

- IT Apriscatole da banco. Struttura in acciaio cementato - coltello in acciaio inox - alzacoperchi magnetico max 20(h) cm.
- EN Counter can opener. Case hardened steel structure - stainless steel knife - magnetic lid lifter max 20(h) cm.
- FR Ouvre-boîte pour comptoir. Structure en acier cémenté - couteau en acier inox - souleveuse de couvercle magnétique max 20(h) cm.
- DE Tisch-Dosenöffner. Einsatzgehärtete Stahlstruktur - Edelmessner - Magnetdeckelheber Max 20(h) cm.



	AV4500	<b>OPTIONAL</b> R4501	<b>OPTIONAL</b> R4502
	10 x 23 x 69(h) cm	Lama di ricambio Spare blade	Ingranaggio ricambio Spare gear
	100 €	12 €	20 €

## AV4585 - AV4586 AV4587

- IT Vassoio in laminato in colore teak.
- EN Teak laminate tray.
- FR Plateau en teck laminé.
- DE Laminatplatte aus Teakholz.



	AV4585	AV4586	AV4587
	Gastronorm 53x32,5 cm	Euronorm 53x37 cm	Esagonale 52x34,5 cm
	18 €	19 €	20 €

Articoli vari per cucina  
Cooking items

## BL4545



IT Bilancia Elettronica, fino a 15 kg con divisione in grammi 5. Corpo in ABS - piatto inox 28x21 cm - acquisizione tara - bolla di livello incorporata - tastiera con protezione antispruzzo - alimentazione a batteria ricaricabile - peso bilancia (batterie escluse) 4,1 kg. Non adatta per la vendita al pubblico.

EN Electronic Scale, up to 15 kg with division in 5 grams. - ABS casing - 28x21 cm stainless steel plate - tare acquisition - built-in level bubble - keyboard with splash protection - rechargeable battery power supply - scale weight (without batteries ) 4,1 kg. Not suitable for retail sale.

FR Balance électronique, jusqu'à 15 kg avec division en 5 grammes. Corps en ABS - plaque en acier inox 28x21 cm - acquisition de la tare - bulle de niveau intégrée - clavier avec protection anti-rayures - alimentation par batterie rechargeable - poids balance (sans piles) 4,1 kg. Ne peut pas être vendue au public.

DE Elektronische Waage bis 15 kg mit Einteilung in Gramm 5. ABS Gehäuse - Edelstahltablette 28x21 cm - Tara-Erfassung - eingebaute Libelle - Tastatur mit Spritzschutz - Akku-Stromversorgung - Waagengewicht (ohne Batterien) 4,1 kg. Nicht für den Einzelhandel geeignet.

## BP4548



IT Bilancia Elettronica, fino a 60 kg con divisione in grammi 20. Corpo in ABS - piatto inox 32x33 cm - acquisizione tara - alimentazione a batteria + alimentatore - peso bilancia (batterie escluse) 4,5 kg. Non adatta per la vendita al pubblico.

EN Electronic Scale, up to 60 kg with division in 20 grams. ABS casing - 32x33 cm stainless steel plate - tare acquisition - battery power supply + transformer - scale weight (without batteries) 4,5 kg. Not suitable for retail sale.

FR Balance électronique, jusqu'à 60 kg avec division en 20 grammes. Corps en ABS - plaque en acier inox 32x33 cm - acquisition de la tare - alimentation par batterie + alimentation - poids de la balance (sans piles) 4,5 kg. Ne peut pas être vendue au public.

DE Elektronische Waage bis 60 kg mit Einteilung in Gramm 20. ABS Gehäuse - Edelstahltablette 32x33 cm - Tara-Erfassung - Akku-Stromversorgung + Netzteil - Waagengewicht (ohne Batterien) 4,5 kg. Nicht für den Einzelhandel geeignet.

	BL4545
	230V - 7 W
	29 x 33 x 22(h) cm
	270 €

	BP4548
	230V - 2 W
	31 x 30 x 5(h) cm
	200 €

**+5%**



## AV4960



IT Pala in alluminio forata -per uso professionale

EN Perforated aluminium peel - for professional use

FR Pelle en aluminium perforée - pour usage professionnel

DE Perforierte Aluminiumschaufel - für den professionellen Einsatz

i	AV4960	AV4961	AV4962	AV4963
↗ cm	33 x 33 x 170(h) cm	36 x 36 x 170(h) cm	45 x 45 x 170(h) cm	50 x 50 x 170(h) cm
	138 €	150 €	180 €	185 €

## AV4926



IT Pala in alluminio - per uso professionale

EN Aluminium peel - for professional use

FR Pelle en aluminium - pour usage professionnel

DE Aluminiumschaufel - für den professionellen Einsatz

i	AV4926	AV4927	AV4930	AV4930/50
↗ cm	33 x 33 x 170(h) cm	36 x 36 x 170(h) cm	45 x 45 x 170(h) cm	50 x 50 x 170(h) cm
	120 €	135 €	162 €	170 €

## AV4925



IT Pala in alluminio FR Pelle pizza en aluminium

EN Aluminium peel DE Aluminiumschaufel

i	AV4925	AV4928	AV4929
↗ cm	33 x 33 x 135(h) cm	33 x 33 x 170(h) cm	36 x 36 x 170(h) cm
	78 €	93 €	100 €

## AV4922



IT Palino in acciaio forato FR Pelle de cuisson en acier perforé

EN Perforated steel turning peel DE Perforierter Brotschieber

i	AV4922	AV4923	AV4968
↗ cm	ø 18 x 170(h) cm	ø 22 x 170(h) cm	ø 26 x 170(h) cm
	92 €	98 €	100 €



## AV4920



IT Palino in acciaio FR Pelle de cuisson en acier

EN Steel turning peel DE Brotschieber

i	AV4920	AV4921
↗ cm	ø 18 x 170(h) cm	ø 22 x 170(h) cm
	84 €	88 €

Accessori per pizzeria  
Pizzeria accessories

+5%

## AV4965



IT Pala in alluminio forni elettrici e a gas  
EN Aluminium peel for electric and gas ovens  
FR Pelle en aluminium fours électriques et à gaz  
DE Aluminiumschaufel Elektro- und Gasöfen

	AV4965
	33 x 35 x 70(h) cm
	46 €



## AV4966

IT Pala per pizza al metro  
EN Peel for pizza by the meter  
FR Pelle à pizza au mètre  
DE Pizza am Stück Schaufel

	AV4966
	60 x 40 x 170(h) cm
	180 €



## AV4905

IT Paletta servi pizza in acciaio  
EN Steel pizza serving peel  
FR Pelle pour servir des pizzas en acier  
DE Pizza-Service Stahlschaufel



	AV4905	AV4931
	ø 50 cm a 8 porzioni ø 50 cm with 8 portions	ø 33 cm
	74 €	48 €

## AV4948

IT Paletta per pizza triangolare in acciaio  
EN Steel triangular pizza paddle  
FR Pelle triangulaire en acier pour pizza  
DE Dreieckiger Stahlschaufel für Pizza



	AV4948
	15 x 25 cm
	40 €

## AV4932

IT Spatola in acciaio inox  
EN Stainless steel spatula  
FR Spatule en acier inox  
DE Edelstahlspachtel



	AV4932
	15 €

+5%

## AV4954

IT Paletta per pizza in acciaio  
EN Steel pizza paddle  
FR Pelle à pizza en acier  
DE Stahlschaufel für Pizza



	AV4954
	10 x 15 cm
	26 €

+5%

## AV4941

IT Pinza prenditeglie  
EN Tray clamps  
FR Pincés prend plaques  
DE Blechklemme



	AV4941
	35 €

## AV4949

IT Rotella taglia pizza professionale  
EN Professional pizza cutter  
FR Roue coupe-pizza professionnelle  
DE Professionelles Pizzaschneidrad



	AV4949
	ø 9 cm
	62 €

## AV4933

IT Bucasfoglia in lega  
EN Alloy puff pastry perforator  
FR Perforateur de pâte feuilletée en alliage  
DE Legierung Blätterteiglöcherer



	AV4933
	65 €

## AV4946

IT Raschietto inox  
EN Stainless steel scraper  
FR Racloir inox  
DE Edelstahl Schaber



	AV4946
	12 cm
	17 €

## AV4934

IT Rotella taglia pizza ø 90 mm  
EN Pizza cutting wheel ø 90 mm  
FR Molette coupe pizza ø 90 mm  
DE Grädchen zur Pizza schneiden ø 90 mm



	AV4934
	ø 9 cm
	20 €

+5%

## AV4911

IT Paletta per cenere  
EN Peel for ashes  
FR Pelle à cendres  
DE Ascheschaufel



	AV4911
	170(h) cm
	80 €

+5%

Accessori per pizzeria  
Pizzeria accessories

## AV4959



IT Spazzola ottone girevole a mezzaluna

EN Brass swivel half-moon brush

FR Brosse pivotante en laiton en forme de demi-lune

DE Schwenkbare Halbmondbürste aus Messing

	AV4959	OPTIONAL A45
	170(h) cm	ricambio spazzolone a mezzaluna spare half moon brush
	100 €	32 €

## AV4971



IT Spazzola doppia / ottone e raschietto in acciaio inox

EN Double brush / brass and stainless steel scraper

FR Brosse double / laiton et racloir inox

DE Doppelbürste / Messing und Edelstahlschaber

	AV4971	
	110(h) cm	
	52 €	

## AV4912



IT Spazzola in fibra naturale

EN Natural fibre brush

FR Brosse en fibres naturelles

DE Naturfaserbürste

	AV4912	OPTIONAL A42
	170(h) cm	Spazzola di ricambio in fibra naturale Natural fibre brush
	72 €	20 €

+5%

## AV4919



IT Spazzola in ottone per forni a legno

EN Brass brush for wood ovens

FR Brosse en laiton pour fours à bois

DE Messingbürste für Holzöfen

	AV4919	OPTIONAL A43
	170(h) cm	spazzola di ricambio in ottone Spare brass brush
	88 €	22 €

+5%

## AV 4970



- IT Kit 3 pezzi 170(h) cm (pala ø 33 cm - palino ø 18 cm - spazzola)  
 EN Kit 3 pieces 170(h) cm (ø 33 cm pizza peel - ø 18 cm turning peel - brush)  
 FR Kit 3 pièces 170(h) cm (pelle ø 33 cm - pelle ø 18 cm - brosse)  
 DE 3-teiliger Satz 170(h) cm (Schaufel ø 33 cm - kleine Schaufel ø 18 cm - Bürste)

	AV 4970
	170(h) cm
	196 €

**+5%**

## AV 4972



- IT Kit 3 pezzi 135(h) cm (pala ø 33 cm - palino ø 22 cm - spazzola)  
 EN Kit 3 pieces 135(h) cm (ø 33 cm pizza peel - ø 22 cm turning peel - brush)  
 FR Kit 3 pièces 135(h) cm (pelle ø 33 cm - pelle ø 22 cm - brosse)  
 DE 3-teiliger Satz 135(h) cm (Schaufel ø 33 cm - kleine Schaufel ø 22 cm - Bürste)

	AV 4972
	135(h) cm
	150 €

Accessori per pizzeria  
 Pizzeria accessories

	AV 4916	
	Cassetta per appoggio pale Peel support box Cassette pour support de pelles Schaufelstützkasten	
		60 €

	AV 4913	
	Supporto reggipale a muro Wall peel support Support mural pour pelles Wandschaufelhalter	
		35 €

	AV4914	
	Supporto reggipale a muro Wall peel support Support mural pour pelles Wandschaufelhalter	
		52 €

## AV4910

- IT Supporto reggipale  
 EN Peel support  
 FR Support de palles  
 DE Schaufelträger

	AV 4910
	135(h) cm
	255 €



**+5%**

## AV4935

IT Tagliere polietilene per pizza

EN Polyethylene cutting board for pizza

FR Planche à découper en polyéthylène pour pizza

DE Pizza-Schneidebrett aus Polyethylen



	AV4935	AV4936
	ø 35 cm	ø 40 cm
	47 €	64 €

## AV4918

IT Alare per appoggio legna

EN Andiron stand for firewood

FR Chenet pour appui bois

DE Tragfläche für Holz



	AV4918
	68 €

## AV4952

IT Retina tonda inox

EN Little round stainless steel net

FR Grille ronde en acier inox

DE Rundes Edelstahlnetz



	AV4952	AV4953
	ø 33 cm	ø 45 cm
	25 €	37 €

## AV4942

IT Oliera in acciaio inox 0,75 l

EN Stainless steel oil dispenser 0,75 L

FR Huilier en acier inox 0,75 L.

DE Edelstahl Ölflasche 0,75 L



	AV4942
	0,75 L
	75 €

## AV4955

IT Retina tonda alluminio

EN Little round aluminium net

FR Grille ronde en aluminium

DE Rundes Aluminiumnetz



	AV4955	AV4956	AV4957
	ø 28 cm	ø 33 cm	ø 45 cm
	13 €	17 €	23 €

## AV4938

IT Contenitore per impasti pizza

EN Pizza dough container

FR Conteneur pour pâte à pizza

DE Pizzateigbehälter



	AV4938	AV4967	AV4939 Coperchio/Cover
	60 x 40 x 7,5(h) cm	60 x 40 x 9(h) cm	60 x 40 cm
	13 €	15 €	11 €

Accessori per pizzeria  
Pizzeria accessories

+5%

+5% forcar®

## AV4973

IT Portapizze rigido, interno in alluminio, per trasporto 10 pizze ø 33 cm.

EN Sturdy pizza holder, internally made of aluminium, for 10 pizzas ø 33 cm.

FR Conteneur thermique pour le transport de 10 pizza ø 33 cm, intérieur en aluminium.

DE Starres Pizzaregal aus Aluminium für den Transport von 10 Pizzas ø 33 cm.

	AV4973
	47 x 47 x 52(h) cm
	275 €



## AV4975

IT Borsa termica 5 pizze ø 33 cm per consegna a domicilio

EN Heating Bag for 5 pizzas ø 33 cm for home delivery.

FR Sac thermique pour 5 pizzas ø 33 cm pour la livraison à domicile.

DE Wärmetasche für den Heimlieferdienst enthält 5 Pizzas ø 33 cm.

	AV4975
	37 x 37 x 20(h) cm
	55 €



+5%

## AV4974

IT Piastra di fissaggio al portapacchi ciclomotore (per art. AV4973)

EN Fixing plate for moped luggage rack (for art. AV4973)

FR Plaque de fixation sur le porte-bagages du cyclomoteur (pour art. AV4973)

DE Befestigungsplatte am Mopedgepäckträger (für Art. AV4973)

	AV4974
	35 x 37 x 6,5(h) cm
	72 €



Accessori per pizzeria  
Pizzeria accessories



# Pattumiere-portarifiuti

GARBAGE AND DUST BINS  
POUBELLES  
MÜLL- UND ABFALLBEHÄLTER



## AV4650-51

- IT Posacenere, gettacarte, pattumiere e portarifiuti - coperchio a rete cromata.
- EN Ashtrays, paper baskets, garbage bins and dust bins - chromed mesh lid.
- FR Cendriers, corbeilles à papier, poubelles et conteneur de déchets - couvercle en filet chromé.
- DE Aschenbecher, Papierkorb, Mülleimer und Abfallbehälter - verchromter Netzdeckel.



	AV4650	AV4651
	ø 20 - 60(h) cm	ø 25 - 70(h) cm
	95 €	145 €

## AV4620

- IT Gettacarte in acciaio inox satinato Autoestinguente, testa soffocante per l'arresto della propagazione del fuoco - capacità 50 L - base in gomma.
- EN Satin stainless steel paper basket, Self-extinguishing, stifling end to stop the propagation of fire - capacity 50 L - rubber base.
- FR Corbeille à papier en acier inox satiné, Eteignant automatiquement, tête suffocante pour arrêter la propagation du feu - capacité 50 L - base en caoutchouc.
- DE Papierkorb aus satiniertem Edelstahl, Selbstlöschend erstickender Deckel zur Verhinderung der Ausbreitung von Feuer - Kapazität 50 L - Gummifuß.



	AV4620
	ø 31 - 59(h) cm
	120 €

+5%

## AV4666-80

- IT Tramoggia su ruote. Struttura in acciaio inox satinato. coperchio asportabile.
- EN Hopper on wheels. Satin stainless steel casing. Removable lid.
- FR Trémie sur roues. Corps en acier inox satiné. Couvercle amovible.
- DE Trichter auf Rädern. Gehäuse aus Edelstahl matt geschliffen. Abnehmbarer Deckel.



	AV4666	AV4680 con separatore interno with internal separator
	61 x 40 x 73(h) cm	61 x 40 x 73(h) cm
	115 L	
	370 €	420 €

## AV4671

- IT Pattumiera con ruote, senza pedale.
- EN Garbage bin with wheels, without pedal.
- FR Poubelle à roulettes, sans pédale.
- DE Mülleimer mit Rädern, ohne Fußhebel.



	AV4671
	ø 39 x 60(h) cm
	63 L
	215 €

+5%

Pattumiere e portarifiuti  
Garbage and dust bins

AV4667  
AV4668

AV4669

AV4660  
AV4661  
AV4663



IT Portarifiuti carrellato. Struttura a forma cilindrica in acciaio inox - completo di coperchio stampato - fondo a tenuta stagna - ruote multidirezionali. AV4667-68 con comando a pedale.

EN Wheeled waste bin. Cylindrical stainless steel structure - Complete with shaped lid - watertight bottom - multidirectional wheels. AV4667-68 with pedal control.

FR Chariot-poubelle. Corps cylindrique en acier inox - complète de couvercle imprimée - fond étanche - roues multidirectionnelles. AV4667-68 avec commande à pédale.

DE Abfalleimer auf Rädern. Zylindrisches Edelstahlgehäuse - mit vorgeformtem Deckel - wasserdichter Boden - Mehrwegräder. AV4667-68 mit Fußhebel.

IT Pattumiere tonde in acciaio inox. Cestello interno in metallo e pedale.

EN Round stainless steel waste bins. Internal metal basket and pedal.

FR Poubelles rondes en acier inox. Boîtier interne en métal et pédale.

DE Runde Abfalleimer aus Edelstahl. Interner Metallkorb und Fußhebel.

i	AV4667	AV4668	AV4669
cm	ø 39 x 60(h) cm	ø 46 x 70(h) cm	ø 46 x 70(h) cm
L	50 L	100 L	100 L
	200 €	230 €	180 €

i	AV4660	AV4661	AV4663
cm	ø 32 x 59(h) cm	ø 32 x 74(h) cm	ø 41 x 71(h) cm
L	30 L	40 L	80 L
	190 €	195 €	325 €

+5%

AV4652  
AV4654



AV4681



IT Pattumiera rettangolare - Struttura in acciaio inox comando apertura a pedale - estrazione sacco anteriore - 2 ruote.

IT Pattumiera portasacco. Attacco rotondo in acciaio inox coperchio con apertura a pedale.

EN Rectangular waste bin - Stainless steel structure pedal opening control - front bag extraction - 2 wheels.

EN Bag holder. Round stainless steel fitting, lid with pedal opening.

FR Poubelle rectangulaire - Corps en acier inox commande d'ouverture par pédale - extraction du sac à l'avant - 2 roues.

FR Poubelle Porte-sac. Support rond en acier inox couvercle avec ouverture par pédale.

DE Rechteckiger Abfalleimer - Gehäuse aus Edelstahl Fußhebelöffnung - vordere Sackentnahme - 2 Räder.

DE Müllsackhalterung. Runder Edelstahldeckel mit Fußhebelöffnung.

	AV4652	AV4654
	49 x 50 x 101(h) cm	49 x 50 x 79(h) cm
	100 L	70 L
	370 €	300 €

	AV4681
	55 x 45 x 85(h) cm
	sacco grande / big bag
	185 €

+5%

Pattumiere e portarifiuti  
Garbage and dust bins

# CA1602 CA1603



# AV4682



IT Carrello portasacco con struttura a X. Disponibile con cestino e struttura verniciata (CA1602) o con comando a pedale e struttura cromata (CA 1603). Attacco rotondo - coperchio in plastica rotondo con aggancio.

EN Bag holder trolley with X structure. Available with basket and painted structure (CA1602) or with pedal control and chromed structure (CA 1603). Round fitting - round plastic lid with fastener.

FR Chariot porte-sac en forme de X. Disponible avec boîtier et structure peinte (CA1602) ou avec commande à pédale et structure chromée (CA 1603). Support rond - couvercle rond en plastique avec raccord.

DE Müllsackwagen mit X-förmige Struktur. Erhältlich mit Korb und lackierter Struktur (CA1602) oder mit Fußhebelöffnung und verchromter Struktur (CA 1603). Runder Anschluss - runder Kunststoffdeckel mit Aufhängung.

IT Pattumiere in polietilene per raccolta differenziata - Struttura colore grigio - coperchio colorato a scelta. Ruote ø 143 mm.

EN Polyethylene waste bins for differentiated collection - Grey structure - coloured lid of your choice. Wheels ø 143 mm.

FR Poubelles en polyéthylène pour collecte différenciée - Structure de couleur grise - couvercle de couleur de votre choix. Roues ø 143 mm.

DE Abfalleimer aus Polyethylen zur getrennten Entsorgung - graue Struktur - farbiger Deckel Ihrer Wahl. Räder ø 143 mm.

i	CA1602	CA1603
↗ cm	58 x 56 x 102(h) cm	58 x 56 x 102(h) cm
	170 €	190 €

i	AV4682Y giallo/yellow	AV4682R rosso/red	AV4682B blu/blue	AV4682G verde/green
↗ cm	54 x 49 x 85(h) cm			
L	80 L			
	50 €			

**+5%**

# AV4675



AV4674



AV4676



AV4678



AV4679



IT Pattumiere in polietilene.  
Diversi colori disponibili.  
Ruote ø 200 mm.

EN Polyethylene waste bins.  
Several colours available.  
Wheels ø 200 mm.

FR Poubelles en polyéthylène.  
Différentes couleurs disponibles.  
Roues ø 200 mm.

DE Abfalleimer aus Polyethylen.  
Erhältlich in verschiedenen Farben.  
Räder ø 200 mm.

## OPTIONAL RC 0075

Pedale apricoperchio per contenitore  
Pedal lid opener for container  
Pédale ouvre-couvercle pour conteneur  
Deckelöffnungsfußhebel

38 €

i	AV4674	AV4675	AV4676	AV4678	AV4679
↗ cm	55 x 48 x 93(h) cm				
L	120 L				
	80 €				

+5%

Pattumiere e portarifiuti  
Garbage and dust bins

# Condizioni generali di vendita

GENERAL SALES CONDITIONS  
CONDITIONS GÉNÉRALES DE VENTE  
ALLGEMEINE VERKAUFSBEDINGUNGEN

IT

**COSTO DELL'IMBALLO:** compreso nel prezzo per le macchine - ricambi ed accessori € 5,00.

**COSTO FISSO GESTIONE ORDINI:** € 5,00 solo per ordini di importo inferiore a € 80,00.

**CONDIZIONI DI PAGAMENTO:** Si richiede il pagamento con bonifico bancario per:

1. prime forniture. - 2. al superamento del fido. - 3. invio dei ricambi.

**DILAZIONI DI PAGAMENTO:** da definire.

**PREZZI:** non sono impegnativi, possono subire variazioni senza obbligo di preavviso, in tal caso saranno confermati all'ordine.

Tutti i prezzi sono esclusi di IVA.

**TERMINI DI CONSEGNA:**

1. Possibile spedizione giornaliera per macchine disponibili a magazzino (solo in Italia).

2. Per macchine da produrre circa 25 giorni salvo imprevisti.

**ASSISTENZA TECNICA:** a carico del RIVENDITORE per tutta la durata della garanzia di anni uno.

Forcar S.r.l. si impegna a fornire, in garanzia, tutti i componenti di ricambio ritenuti difettosi. Il prezzo di vendita fatturato all'utilizzatore finale comprenderà non solo il prezzo dei prodotti finiti venduti ma anche la gestione, da parte del rivenditore, della garanzia a copertura di essi. Forcar S.r.l. non dovrà sostenere alcuna spesa diretta o indiretta sostenuta dal rivenditore per la gestione della garanzia.

**INSTALLAZIONE:** a carico del rivenditore.

**TRASPORTO:** FRANCO FABBRICA, la merce viaggia a rischio e pericolo del committente, per cui Forcar S.r.l. non è responsabile per eventuali danni subiti dalla merce durante il trasporto. Eventuali contestazioni dovranno essere effettuate all'atto della consegna entro i termini di legge.

**GARANZIA:** 12 mesi.

**ASSICURAZIONE:** tutte le nostre macchine sono coperte da assicurazione (responsabilità civile verso terzi) Escluso U.S.A. e CANADA.

**CATALISTINO:** la presente documentazione annulla tutte le precedenti. I dati tecnici, le illustrazioni e le immagini riportate nel presente sono puramente indicativi. La Ditta si riserva il diritto di modificare le caratteristiche tecniche ed estetiche o sospendere, in ogni momento, la propria produzione senza obbligo di preavviso.

**IMMAGINI ED ILLUSTRAZIONI:** tutte le immagini realizzate dal produttore sono coperte da copyright. L'utilizzo o la riproduzione delle medesime sono soggetti ad autorizzazione da parte della Ditta proprietaria del marchio e detentrica dei diritti di proprietà materiale ed intellettuale. I prezzi potranno subire variazioni nel caso di errori tipografici

**MARCHI E BREVETTI:** è fatto espresso divieto di utilizzare i marchi e/o i brevetti registrati dalla Forcar S.r.l.

Si precisa che tutti i macchinari e gli accessori non marcati CE presentano caratteristiche specifiche che non li rendono idonei alla vendita all'interno dei paesi dell'Unione Europea.

MOD089V04 - FINITO DI STAMPARE NEL SETTEMBRE 2019

EN

**PACKAGING COST:** included in the price of the machines - spare parts and accessories € 5,00.

**ORDER MANAGEMENT FIXED FEE:** € 5,00 only for orders of less than € 80,00

**PAYMENT TERMS:** Payment by bank transfer is required for:

1. first orders. - 2. in the event that the exposure is exceeded.

3. spare parts delivery.

**PAYMENT DEFERMENT:** to be defined.

**PRICES:** are not binding, may change without notice, in which case they will be confirmed with the order. Prices not include VAT.

**DELIVERY TERMS:**

1. Daily shipping possible for machines available in stock (in Italy only).

2. Delivery possible within 1 week from order for goods in stock.

3. For machines to be produced about 25 days unless unforeseen events occur.

**TECHNICAL SUPPORT:** to be provided by the DEALER for the duration of the warranty period of one year.

Forcar S.r.l. undertakes to supply, on warranty, all spare parts considered defective. The sales price invoiced to the end user will include not only the price of the end products sold but also the management, by the retailer, of their warranty. Forcar S.r.l. shall not incur any direct or indirect expenses borne by the retailer for the management of the warranty.

**INSTALLATION:** to be performed by the dealer.

**TRANSPORT:** EX WORKS, the goods travel at risk and danger of the customer, Forcar S.r.l. is not responsible for any damage suffered by the goods during transport. Any disputes must be made at reception within the terms of the law.

**WARRANTY:** 12 months.

**INSURANCE:** all our machines are covered by insurance (third party liability) Excluding U.S.A. and CANADA.

**CATALOGUE & PRICE LIST:** This documentation voids all previous documentation. Technical data, drawings and images in this catalogue are purely indicative. The Company reserves the right to modify the technical and aesthetic characteristics or suspend, at any time, its production without notice.

**IMAGES AND DRAWINGS:** all images made by the manufacturer are protected by copyright. The use or reproduction of the same is subject to authorization by the trademark owner who holds the material and intellectual property rights. Prices may vary in the event of misprints.

**BRANDS and PATENTS:** it is expressly forbidden to use the trademarks and/or patents registered by Forcar S.r.l.

It should be noted that all machinery and accessories not bearing the CE mark have specific characteristics that make them unsuitable for sale within the countries of the European Union.

MOD089V04 - PRINTED IN SEPTEMBER 2019

FR

**FRAIS D'EMBALLAGE:** inclus dans le prix des machines - pièces détachées et accessoires € 5,00.

**FRAIS DE GESTION DE COMMANDE:** € 5,00 uniquement pour les commandes inférieures à € 80,00

**PAIEMENT:** Le paiement par virement bancaire est requis pour:

1. premières fournitures. - 2. l'excès du risque d'exposition.

3. l'envoi de pièces détachées.

**PAIEMENTS DILATÉS:** à définir.

**PRIX:** ils ne sont pas contractuels, peuvent être modifiés sans préavis, auquel cas ils seront confirmés lors de la commande. Tous les prix s'entendent hors TVA.

**CONDITIONS DE LIVRAISON:**

1. Possibilité d'expédition sur la journée pour les machines disponibles en stock (uniquement en Italie).

2. Possibilité de livraison dans un délai d'une semaine à compter de la date de commande pour les produits en stock.

3. Pour les machines à produire environ 25 jours, sauf circonstances imprévues.

**ASSISTANCE TECHNIQUE:** à imputer au DISTRIBUTEUR pour la durée de la garantie d'un an.

Forcar S.r.l. s'engage à fournir, sous garantie, toutes les pièces détachées considérées comme défectueuses. Le prix de vente facturé à l'utilisateur final comprendra non seulement le prix des produits finis vendus mais aussi la gestion, par le distributeur, de la garantie qui les couvre. Forcar S.r.l. n'encourt aucun frais direct ou indirect pour la gestion de la garantie.

**INSTALLATION:** à imputer au revendeur.

**TRANSPORT:** EX WORKS, les marchandises voyagent aux risques et périls du client, Forcar S.r.l. n'est donc pas responsable des dommages subis par les marchandises pendant leur transport. Toute contestation doit être faite au moment de la livraison dans les conditions prévues par la loi.

**GARANTIE:** 12 mois.

**ASSURANCE:** toutes nos machines sont couvertes par une assurance (responsabilité civile) sauf les États-Unis et le Canada.

**CATALOGUE ET LISTE PRIX:** Cette documentation annule toute la documentation précédente. Les données techniques, illustrations et images de cette documentation sont données à titre purement indicatif. La Société se réserve le droit de modifier les caractéristiques techniques et esthétiques ou de suspendre, à tout moment, sa production sans préavis.

**IMAGES ET ILLUSTRATIONS:** toutes les images réalisées par le fabricant sont couvertes par le droit d'auteur. L'utilisation ou la reproduction de ceux-ci est soumise à l'autorisation de la société propriétaire de la marque et titulaire des droits de propriété matérielle et intellectuelle. Les prix peuvent varier en cas d'erreurs typographiques.

**MARQUES ET BREVETS:** il est expressément interdit d'utiliser les marques et/ou brevets déposés par Forcar S.r.l.

Il est à noter que toutes les machines et accessoires sans marquage CE présentent des caractéristiques spécifiques qui les rendent impropres à la vente dans les pays de l'Union Européenne.

MOD089V04 - PUBLIÉ EN SEPTEMBRE 2019

DE

**VERPACKUNGSKOSTEN:** Im Maschinenpreis enthalten - Ersatzteile und Zubehör € 5,00.

**FESTE AUFTRAGSVERWALTUNGSKOSTEN:** € 5,00 nur bei einem Bestellwert unter € 80,00.

**ZAHLUNGSBEDINGUNGEN:** Die Zahlung per Banküberweisung ist erforderlich bei:

1. erste Lieferungen. - 2. Überschreitung der Kreditgrenze.

3. Versand von Ersatzteilen.

**ZAHLUNGSAUFSCHUB:** nach Absprache.

**PREISE:** sind nicht verbindlich, können ohne Vorankündigung geändert werden, in diesem Fall werden sie bei der Bestellung bestätigt. Alle Preise verstehen sich zuzüglich der gesetzlichen Mehrwertsteuer.

**LIEFERBEDINGUNGEN:**

1. Möglicher Tagesversand für lagerhaltige Maschinen (nur in Italien)

2. Möglicher Versand der Ware innerhalb von 1 Woche nach Bestellung für lagerhaltige Produkte.

3. Für Neumaschinen, ca. 25 Tage, vorbehaltlich unvorhergesehener Umstände.

**TECHNISCHE UNTERSTÜTZUNG:** zu Lasten des Wiederverkäufers für die Dauer der Garantie von einem Jahr.

Forcar S.r.l. verpflichtet sich, im Rahmen der Garantie alle als defekt geltenden Ersatzteile zu liefern. Der dem Endverbraucher in Rechnung gestellte Verkaufspreis umfasst nicht nur den Preis der verkauften Endprodukte, sondern auch die Verwaltung ihrer Garantie durch den Wiederverkäufer. Forcar S.r.l. ist nicht verpflichtet, dem Wiederverkäufer direkte oder indirekte Kosten für die Verwaltung der Garantie zu erstatten.

**INBETRIEBNAHME:** zu Lasten des Wiederverkäufers.

**VERSAND:** EX WORKS, die Waren reisen auf Gefahr und Risiko des Kunden, Forcar S.r.l. ist nicht für Schäden an der Ware während des Versands verantwortlich. Etwaige Streitigkeiten müssen zum Zeitpunkt der Lieferung im Rahmen der gesetzlichen Bestimmungen geltend gemacht werden.

**GARANTIE:** 12 Monate.

**VERSICHERUNG:** Alle unsere Maschinen sind durch eine Versicherung (Haftplicht) abgedeckt, mit Ausnahme in den USA und KANADA.

**LISTEN-KATALOG:** die vorliegende Unterlage ersetzt sämtliche früheren Versionen. Die technischen Daten, Abbildungen und Bilder in dieser Unterlage dienen nur der Information. Das Unternehmen behält sich das Recht vor, die technischen und ästhetischen Eigenschaften zu ändern oder die Produktion jederzeit und ohne Vorankündigung einzustellen.

**BILDER UND ZEICHNUNGEN:** alle vom Hersteller hergestellten Bilder unterliegen dem Urheberrecht. Die Verwendung oder Vervielfältigung derselben bedarf der Genehmigung der Eigentümerfirma der Marke und der materiellen und geistigen Eigentumsrechte. Preisänderungen sind aufgrund von Schreibfehlern möglich.

**MARKEN UND PATENTE:** es ist ausdrücklich verboten, die von Forcar S.r.l. registrierten Marken und/oder Patente zu verwenden.

Wir weisen darauf hin, dass alle Maschinen und Zubehörteile, die nicht mit dem CE-Zeichen gekennzeichnet sind, besondere Merkmale aufweisen, die sie für den Verkauf in den Ländern der Europäischen Union ungeeignet machen.

**MOD089V04 - FERTIGGESTELLT IM SEPTEMBER 2019**



**forcar**<sup>®</sup>  
ANNIVERSARY

**Forcar S.r.l.**

Via Sandro Pertini, 14 - 47826 Villa Verucchio (Rimini) Italy  
t: Tel. +39 0541 670529 - f:+39 0541 670064 - mail@forcar.it



FORCAR.IT